



ZEISS Hunting Catalogue 2019



AT ONE WITH THE WILDERNESS

The love of nature is the main reason for going hunting. This love, however, also means meeting the wilderness and the elements up-close. In the cold, in the heat and in rough terrain. This is the only way to truly encounter the heart and soul of nature.

For this, companions that can master these tough conditions are essential. Ones that can be relied on in every situation. Precisely matched to every individual's needs, they must face the wilderness up-close and effortlessly deliver peak performance in even the most demanding conditions. The ZEISS brand stands for these qualities.





RIFLESCOPES
FROM ZEISS
18



ZEISS
HUNTING APP
14



BINOCULARS
FROM ZEISS
36



SPOTTING
SCOPES
FROM ZEISS
58

Precisely tailored to your needs

Whether you choose from the Victory®, Conquest® or Terra® lines, ZEISS always offers the ideal product to fulfil the most stringent personal expectations and the different challenges of every type of hunting. Uncompromising design, ergonomics and looks, and simultaneously robust and easy to use – riflescopes, binoculars and spotting scopes made by ZEISS.

Augmented Reality	6
Real-life Hunting Optics	8
Carl Zeiss AG – the company	12
ZEISS Hunting App	14
ZEISS Hunting on Instagram	56
RIFLESCOPES	18
Victory V8	24
Victory HT	27
Conquest V6	28
Conquest V4	30

BINOCULARS	36
Victory SF	40
Victory Rangefinder System	42
Victory HT	44
Victory FL	46
Victory Pocket	48
Conquest HD	50
Terra ED	52

SPOTTING SCOPES	58
Victory Harpia	62
Conquest Gavia	66
SPECIALS	54
Night Vision	54
Monos	55
20x60	55
Dialyt	68

TECHNICAL SPECS	70
Riflescopes	70
Binoculars	74/82
Spotting scopes	78
ACCESSORIES	80
Accessories for riflescopes	80
Accessories for spotting scopes	81
Accessories for binoculars	81

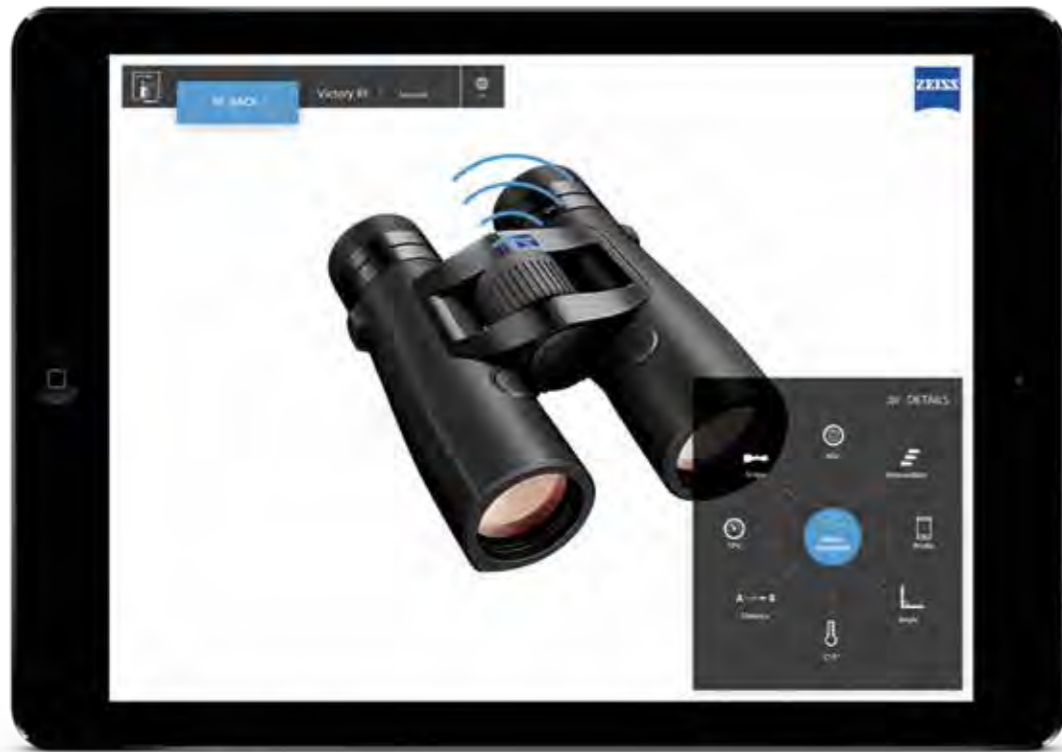

The rangefinder is just one of the numerous products you can discover and explore with the app.



Use this picture as a placeholder for our AR App.
Note: always keep a part of the picture in the field of view of the camera

AUGMENTED REALITY

SEE FURTHER: ZEISS AR SPORTS OPTICS APP

Technical innovation is as deeply rooted in the DNA of ZEISS as the commitment to uncompromising quality in even the smallest of details. Our new app links these two topics – and raises the ZEISS optics product experience to an entirely new level.

Thanks to the innovative ZEISS AR Sports Optics App, you can now take a look around inside our extremely complex optics products from

your mobile device. Features like the distance-measuring system of the Victory Rangefinder System or adjustment of the illuminated dot in the Victory V8 are now not only made visible, but also easy to grasp.

Numerous pages of this catalogue – including the following page – serve as ‘markers’ for the app. All you need to do is hold your device above the marker pages to discover perfectly detailed 3D models of our products.

You can take a walk around each of the products, get up-close to them or take direct control of the animation. Discover what makes ZEISS a legendary name while you’re there: the undying passion for precision and quality – even down to the tiniest screw.

1. Download and install the ZEISS AR Sports Optics App

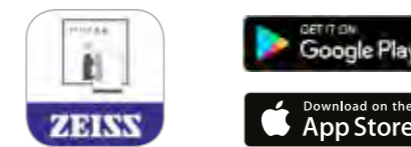

2. Activate the App and hold your device above a catalogue page that contains a ZEISS AR logo

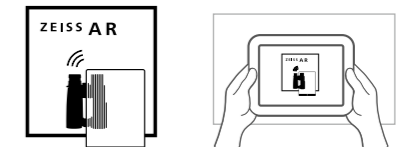

3. Select a product and activate the animation by touch



4. Move your tablet or smartphone to discover new angles and perspectives



LABORATORY TESTED – PROVEN OUTDOOR PERFORMERS



Simulation of extreme situations: extreme temperature variations within minutes and shot simulations at 1,500 times the force of gravity.

Take no chances: ZEISS quality is proven not only in the laboratory, but also on tough hunting trips.

For more than a century, ZEISS has been manufacturing premium optical products that stand out due to their optical excellence, technical innovations and outstanding ergonomics.

Nevertheless, it is not only the pursuit of perfection that makes ZEISS optics what they are. Hunting optics are not scientific instruments; they are tools that must deliver the best in the toughest hunting conditions at all times.

A jacket with a tear or leaking boots are annoying, but a defective rifle or

optical device can ruin what promised to be a good day's hunting. This is why our watchword is absolute reliability – even in the most adverse conditions.

Supreme confidence, whatever the weather

Thanks to the best materials and uncompromising manufacturing quality, we can guarantee a level of reliability and ruggedness that is appreciated by hunters around the world.

Again and again, hunters and their equipment must face and overcome harsh climatic conditions and difficult

terrain. If a torrential downpour begins when you are waiting for game to appear, there's usually only one piece of advice to follow: sit it out! Hoping that your optics are waterproof should be the least of your problems. Exposure to vigorous salt spray when hunting in coastal regions is just as impossible to avoid as extreme temperature variations when leaving the warmth of your vehicle and stepping out into the cold winter air.

Environmental factors are, however, only one part of the equation. A fall in rugged terrain with a shouldered rifle, the rifle falling to the floor of a

high seat or a bumpy ride in the back of a vehicle on rough tracks are all situations in which the resilience of your optics is put to the test.

Your ZEISS optics are ready to face it all

This is why all ZEISS optics are extensively tested in the company's own laboratory to assure their endurance and suitability for everyday use. Proven testing procedures push the optics to the absolute limit. ZEISS conducts special testing procedures for this. Whether transport simulation, continuous impacts, shot simulations with 1,500 times the force of gravity,

24-hour corrosion testing in vigorous salt spray or checking waterproofness by immersion – all these tests simulate stresses that are many times higher than those encountered in normal hunting situations. These stringent testing procedures guarantee trouble-free performance in the often-harsh conditions of everyday hunting and enable you to act with supreme confidence in your equipment at the decisive moment – and that for years and decades to come.



No holds barred:

View our video and see how Anette Dahl and Marius Elpers put the robustness and resilience of their ZEISS optics to the test in a wide range of different hunting situations:

www.youtube.com/user/zeissportsoptics



Marius Elpers (Germany) shows his guest Anette Dahl (Norway) his hunting grounds.



DID YOU KNOW THAT ...

SEMICONDUCTOR MANUFACTURING TECHNOLOGY (SMT)

... a large proportion of all microchips produced around the globe is manufactured with technologies from ZEISS?

ZEISS supplies equipment for semiconductor manufacturing to the Dutch company ASML, the world's largest producer of wafer steppers and wafer scanners – extremely complex machines for manufacturing microchips. Contact between the two companies was established around 30 years ago:

... ZEISS makes driving safer? (DriveSafe)

Developed together with research institutes, ZEISS DriveSafe spectacle lenses are optimised to meet the visual needs of drivers. The special lens coating reduces glare by attenuating the proportion of short wavelength light. In addition to this, ZEISS DriveSafe lenses offer optimised fields of vision for dynamic vision and, in return, a more relaxed view for wearers of varifocal spectacles. Former Formula One racing driver Christian Danner also relies on this technology.

... numerous Oscar-winning films were shot with ZEISS lenses?

Cinematography lenses from ZEISS helped to create the unmistakable, atmospheric mood of numerous Oscar-winning films like *The Lord of the Rings*, *King Kong* and *Perfume: The Story of a Murderer* – the jury of the Academy of Motion Picture Arts and Sciences awarded three technical Oscars to these cinematographic innovations. In 2012 two engineers from ZEISS were presented with the prestigious Scientific and Engineering Award for the mechanical and optical design of the ZEISS Master Prime cinematography lenses jointly developed by ZEISS and the camera manufacturer ARRI. In 1999 the company received the award for the concept and optical design of zoom lenses with the optical performance of prime lenses (Variable Prime) and, in 1987, for the design and development of extremely fast lenses (Super Speeds).

... that the dwarf planet Pluto was discovered with optical technology from ZEISS?

On 18 February 1930, Clyde Tombaugh, a research assistant at the Lowell Observatory in Arizona (United



States) discovered Planet X, today better known as Pluto. His discovery was made with the aid of a so-called blink comparator from ZEISS, as the German planetologist Ulrich Köhler from Schwäbisch Gmünd found out, 85 years after the discovery of Pluto. A blink comparator has an eyepiece similar to that of a microscope and is used to flick quickly, or 'blink', between two photographs of particular segments of the night sky taken at different times to identify changes.

SPORTS OPTICS

... ZEISS was the first to bring binoculars with mechanical image stabilisation to the market?

With the 20 × 60 S, ZEISS became the world's first manufacturer to launch a pair of binoculars with mechanical image stabilisation that allowed shake-free handheld viewing with 20x magnification.

... ZEISS constructed the first riflescopes with reticle illumination as long ago as 1921?

The Zieldovier and Zieldosechs models were the first two riflescopes that ZEISS offered not only with variable magnification, but also with reticle illumination. The riflescopes featured a light tube on the side that could be fitted with an illuminating device. This accessory was supplied only at the special request of customers. A fine adjustment

control regulated the brightness of the illumination to allow it to be adapted to the visibility of the game.

... ZEISS revolutionised riflescope mounting?

The introduction of the ZEISS inner rail in 1990 meant that gunsmiths no longer needed to perform the laborious tasks of cementing and drilling the individual components to attach them to the riflescope. Since the patent expired in 2008, the ZEISS inner rail is now offered by almost all prominent European manufacturers.

ZEISS TODAY AND TOMORROW

... ZEISS constantly sets new standards?

Characterised by a spirit of innovation and progress, the 170-year history of the company is reflected in every idea, every product and in every service offered by ZEISS. Because, just as the world of nature constantly changes and never stands still, ZEISS works with untiring scientific curiosity and unconditional passion – always questioning the status quo and setting new standards with technical innovations.



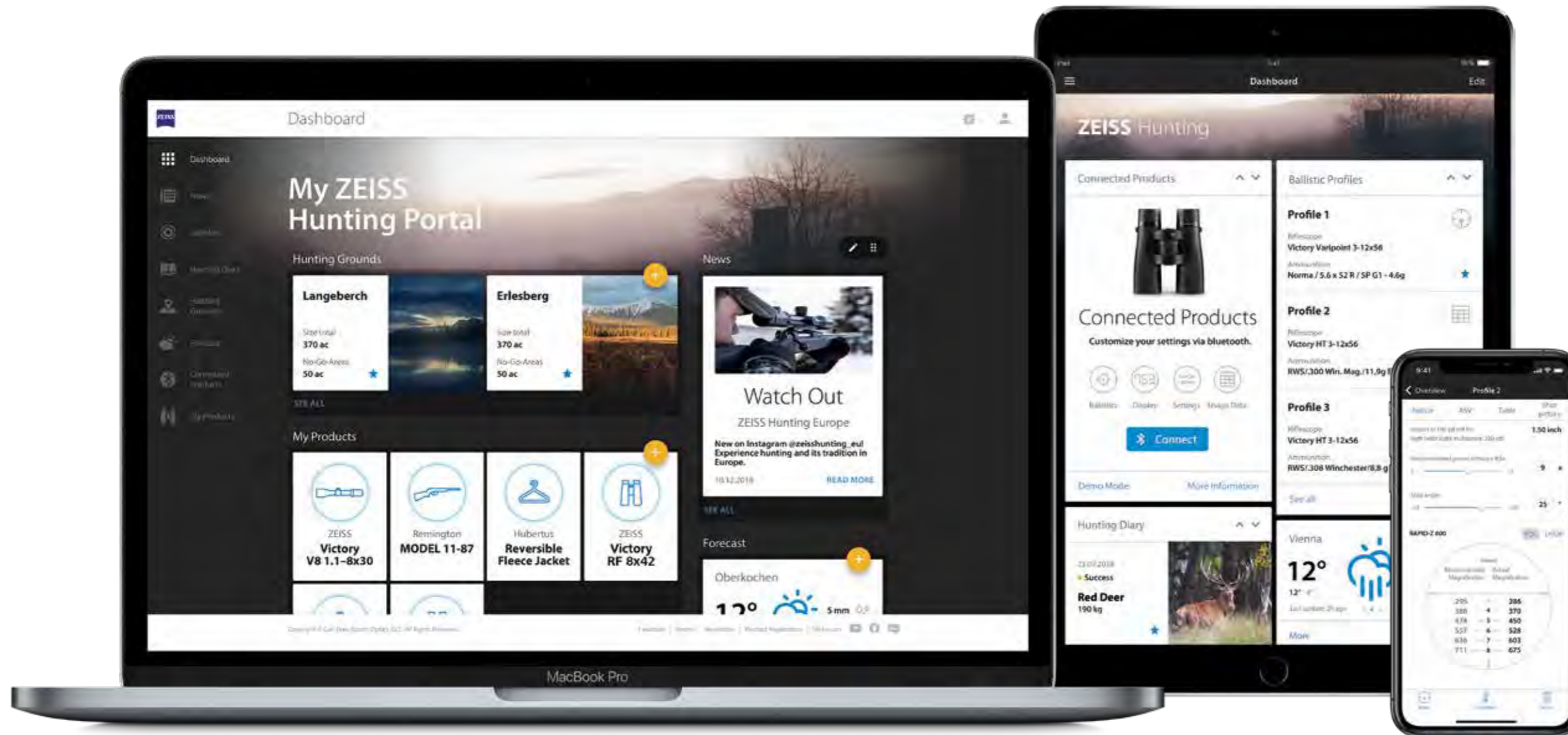

THE APP FOR TODAY'S HUNTERS: NOW ALSO AVAILABLE FOR YOUR BROWSER





The versatile hunting companion
More than 100,000 hunters around the globe already enjoy the benefits of the versatile functions of the ZEISS Hunting App. Always at hand in the field, the app enables hunters to document hunting events and experiences as they happen. The new browser version makes inputting data much more convenient and provides an additional platform for administration and documentation. Thanks to continuous synchronisation, all data input are available on all connected devices – in the app and in the browser.

 **The ZEISS Hunting App – now available for browsers:**
hunting.zeiss.com

 **Connected products**
Simple configuration of the ZEISS Rangefinder in the app (see page 42). Synchronisation of personal ballistic profiles for precise results and accurately placed shots.

 **Hunting grounds**
Create maps of hunting grounds and manage them from the app or your browser. Conveniently mark important locations on the map and display your current position as a useful aid to orientation in the field.

 **Dashboard**
Personally configurable start screen with direct navigation to your features.

 **News**
Special offers, competitions and the latest products news exclusively for ZEISS Hunting users.

 **Hunting diary**
Documentation of all experiences relevant to hunting with information about game and shots, photos, videos and more.

 **Weather forecast**
Weather forecasts for hunting with information relating to the current location and preferred hunting grounds.

 **My products**
Create a clear and detailed overview of your hunting equipment. Enjoy instant access to important product information from a single source.

 **Ballistics**
Ballistic calculations matched to your ZEISS riflescope and ballistic reticle/BDC (ASV), including ammunition database with over 7,000 entries.

SET UP AND MANAGE HUNTING GROUNDS

Hunting diary entries

Add hunting successes to your hunting grounds; these will be shown on your hunting ground maps.

Raised hide

Points of interest

Mark important points in your hunting grounds and define your line of sight.

Hunting grounds

Mark the boundaries of your hunting grounds on the map.

Live location

Your current position is an aid to orientation.

Out of bounds

Mark special areas that are out of bounds.

Wind direction

As an aid to selecting the right high seat.

Geofencing

The app notifies you when you trespass outside your hunting grounds.



THE ZEISS HUNTING APP – available free of charge; download from the App Store or Google Play. Find out more about the app at www.zeiss.de/hunting-app

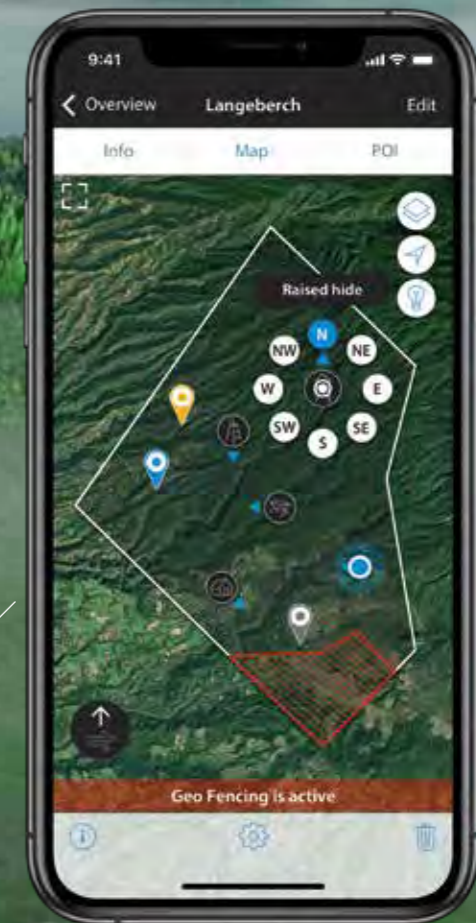
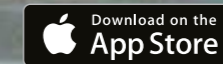



RIFLESCOPES FROM ZEISS

DEDICATED TO A PERFECT VIEW OF YOUR GAME

The experiences made by every individual when hunting are as varied as their demands on their riflescope. The awareness of this enables ZEISS design engineers to develop the perfect riflescopes to meet each hunter's individual needs.

Riflescopes must take the needs of different hunting types and personal needs with regard to weight, magnification, field of view, handling and the brightness and clarity of the viewing image into account.

ZEISS has found the ideal answer to this. This comprises a range of models that offers a broad spectrum of product features and performance profiles that caters for the specific needs of every hunting situation. Despite their differences,

all these models have one thing in common – exceptional quality, made by ZEISS. This also justifies the claim that no matter what challenges you encounter when hunting, ZEISS always has the ideal optics to master them. Thanks to a selection of reliable premium products that address and fulfil individual needs and expectations, you always have the best companion at your side: ZEISS.

Our online product guide will lead you step by step to the perfect ZEISS riflescope for your specific needs: www.zeiss.com/productadvisor-hunting



SEE PERFECTION IN MORE DIMENSIONS

DOWNLOAD THE ZEISS AR SPORTS OPTICS APP. GAIN DETAILED INSIGHTS INTO THE QUALITY, CONSTRUCTION AND FUNCTIONALITY OF THE RIFLESCOPES FROM ZEISS.



Maximum precision

The world's finest and brightest illuminated dot

Revolutionary brightness and image contrast

SCHOTT High-transmission glasses

Extreme versatility

Highest magnification ranges

ZEISS VICTORY RIFLESCOPES

THE UNCOMPROMISING PURSUIT OF PERFECTION

Hunting leaves little room for compromises. This is why dedicated hunters around the world place their complete trust in ZEISS Victory riflescopes – the measure of all things.

It is the sum of sophisticated features and the perfect interplay between these features that makes riflescopes from ZEISS indispensable hunting companions: scanning the hunting terrain delivers an image with razor-sharp details and brilliant colour. This is made possible only by the unique combination of transmission values of up to 95 per cent, FL lenses, SCHOTT HT glasses and extremely wide fields of view.

The handling ergonomics of the riflescopes is also uncompromisingly good. For instance, the world's finest and brightest illuminated dot can be precisely adjusted and easily set, while the short and compact construction ensures the best weapon-handling characteristics. Their extreme long-range capabilities are naturally also among the outstanding characteristics of the riflescopes. Thanks to the new BDC (ASV) LongRange and its large adjustment range, the new ZEISS Victory V8 stands at the pinnacle of modern riflescope technology.

FACTS:

Intelligent innovations for exceptional results:

HT glass from SCHOTT:

Simply 'brighter'. The utilisation of high-transmission (HT) glass ensures a visible increase in light transmission.

Glassless reticle:

It lies in the second image plane and guarantees a constant, fine illuminated dot throughout the entire magnification range. This results in minimum target coverage and noticeably higher aiming accuracy at long distances.

LotuTec® coating:

The dust, dirt and water-repellent coating guarantees a permanently clear view.

Excellent ergonomics:

Functional control elements, intelligent illuminated dot control and robust engineering provide clear proof that the development of ZEISS riflescopes are founded on real-life hunting experiences.

FOCUSING ON THE ESSENTIALS

A COMPARATIVE OVERVIEW OF ALL ZEISS RIFLESCOPES

	Light transmission	Optical quality	BDC (ASV)	Illuminated dot control	Reticle	Mounting	Main use				
	HT	UFL	FL	LotuTec	T*		Driven hunt	Stalking	High seat/night	Medium range/alpine hunting	Long range
ZEISS Victory HT	95%	HT	9	Ballistic rings available as standard ↓ Direct read-out of shot distances Retrofittable BDC (ASV)	Multifunction button Stepless illuminated dot brightness control Finest illuminated dot for minimum target coverage Automatic deactivation	Reticle 60 Ring and inner rail		HT 2.5-10x50	HT 3-12x56		
ZEISS Victory V8	92%	UFL	9	Ballistic rings available as standard ↓ Direct read-out of shot distances Retrofittable BDC (ASV)	Optimised multifunction button, left- or right-handed use Stepless illuminated dot brightness control Finest illuminated dot for minimum target coverage Automatic deactivation with attitude sensor	Reticle 43 Reticle 54 Reticle 60 Ring and inner rail	V8 1.1-8x30	V8 1.8-14x50	V8 2.8-20x56	V8 4.8-35x60	
ZEISS Conquest V6	92%	FL	FL	Turret design enables multiple rotations for precise shots at extreme distances Retrofittable BDC (ASV)	Multifunction button Stepless illuminated dot brightness control Finest illuminated dot for minimum target coverage Automatic deactivation with attitude sensor	Reticle 20 (Z-Plex) Reticle 43 (non-illuminated) Reticle 60 ZMOA-1 ZMOA-2 ZBR-1 ZBR-2 Ring and inner rail	V6 1.1-6x24	V6 2-12x50	V6 2.5-15x56	V6 3-18x50	V6 5-30x50
ZEISS Conquest V4	90%	FL	FL	Turret design enables multiple rotations for precise shots at extreme distances BDC (ASV) not retrofittable	Multifunction button Ten-step dot brightness control	Reticle 20 (Z-Plex) Reticle 60 ZMOAi-1 ZMOA-1 ZMOA-2 ZBR-1 ZBR-2 Ring	V4 1-4x24	V4 3-12x56	V4 4-16x44	V4 6-24x50	

HT Ultra-HT concept
High Transmission SCHOTT glasses for optimum identification and resolution of targets in low light.

LotuTec
For fast and easy cleaning of exposed lens surfaces.

UFL Ultra-FL Concept
Optical system containing several SCHOTT fluoride glasses for absolute colour fidelity, brightness, clarity and the finest resolution of details.

T* Multi-layer coating for a bright, crystal-clear and high-contrast viewing image.

FL Fluoride glass
SCHOTT fluoride glass for a bright viewing image and optimum target resolution.





PRODUCT PORTRAIT

THE MOST VERSATILE RIFLESCOPE: ZEISS VICTORY V8

Hunting has many facets. Driven hunts, stalking or shooting from high seats have different needs and seasonal requirements. The weather and the terrain also influence the difficulty of hunting conditions. These special needs demand an uncompromising riflescope.

The ZEISS Victory V8 is optimised for all hunting situations, and is therefore the global reference standard. It is very impressive with numerous innovations and sets an entirely new standard in the premium class. No other riflescope has

ever been so flexible and versatile. The main reasons for this are its maximum zoom and reticle adjustment ranges. Hunters can also look forward to new standards in terms of ergonomics. For instance, the world's finest and brightest illuminated dot can be precisely adjusted and easily set, while the short and compact construction ensures the best weapon-handling characteristics. The crowning glory of the Victory V8 is ASV LongRange, which, thanks to its large adjustment range, enables precise shots at maximum distances. Regardless of the hunting situation, the Victory V8 always guarantees absolute precision and perfection.

OPTICAL EXPERTISE

The world's finest illuminated dot

The secret behind the precision of ZEISS riflescopes is their ultra-fine illuminated dot and its extremely low target coverage. With only a fraction of the thickness of a human hair, the fibre optics system delivers the world's finest illuminated dot – 3.3-millimetre target coverage at 100 metres is the breathtaking result. Pure precision for the smallest targets and the greatest distances.

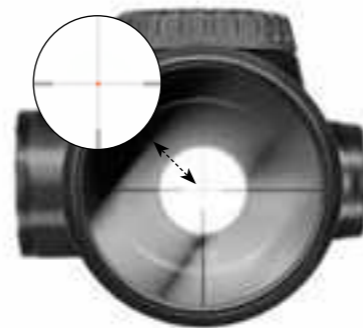

True long-range shooting capability

With an adjustment range of up to 100 clicks, the BDC (ASV) LongRange (ASV LR/ASV Competition) enables accurate aiming at distances of up to 600 metres. Long distances are no longer an obstacle.

Cutting-edge technologies

In combination with the multifunction button for control of the illuminated dot, an intelligent motion sensor system automatically activates the illuminated dot as soon as the rifle is raised to take aim. This enables hunters to concentrate on the essentials.

Precise images

Perfect aim at all distances, thanks to parallax compensation as a standard feature.

Performance-oriented design

The 36-millimetre centre tube diameter offers more room for optical excellence and a greater reticle adjustment range to maximise the chances of hunting success in every situation.

Short reaction time

Rapid aiming is ensured by large exit pupils and maximum field of view at low magnification factors.



**V8 1.1–8×30**

The up to 8x magnification range fulfils the needs of real-life hunting practice in driven hunts and when stalking, and is ideally suited for target acquisition with both eyes open and quick shots at short distances. An unusually wide field of view maximises the overview for shooters on driven hunts and when stalking.

**V8 1.8–14×50**

From driven hunts and stalking to stand hunting. The large zoom range with parallax compensation and relaxed viewing characteristics make this riflescope an ideal companion in every situation.

**HT 2.5–10×50**

The all-rounder for all hunting applications: whether you are shooting on the move or stand hunting, the optional BDC+ (ASV+) makes this riflescope ideal for every hunting situation. The optical concept of the ZEISS Victory HT reveals its true strengths especially in the twilight hours.

**HT 3–12×56**

The specialist for stand hunting at night. The SCHOTT HT glass of the brightest riflescope from ZEISS ensures maximum night hunting capability. In combination with the optional BDC+ (ASV+), the Victory HT also guarantees hunting success at long ranges.

**V8 2.8–20×56**

The 20x magnification and bullet drop compensation as a standard feature make this model an ideal choice for long-range shots. In addition, the 92 % transmission offers outstanding reserves for shooting into the last hours of daylight.

**V8 4.8–35×60**

The benchmark model of the Victory V8 line. The 35x magnification combined with the BDC (ASV Competition) stands for ultimate long-range shooting capability. The optical system of the Victory V8 impresses with consistently excellent sharpness and the highest resolution of details from minimum to maximum magnification.

ACCESSORIES**Bullet drop compensator BDC (ASV)**

Direct read-out of shot distances makes the BDC (ASV) the world's most precise long-range shooting concept. This accessory enables accurate aiming at distances of up to 600 metres.

**Flip cover for the Victory V8/Victory HT**

The high-quality, extremely durable front lens cap is screwed into the lens filter thread and offers perfect protection in any weather conditions. It can be fixed in any position and is suitable for use by left- and right-handed shooters. The field of view is not impaired and its handling while hunting is simplistic.

THE HIGH-PERFORMANCE RIFLESCOPE WITH A **6x ZOOM RANGE:** ZEISS CONQUEST V6

Fast and precise

The optional bullet drop compensation enables accurate aiming at maximum hunting distances. The large exit pupil enables rapid aiming.

Advanced technology

Automatic activation and deactivation of dot illumination by intelligent motion sensor technology extends battery life and, in turn, the length of time the illuminated dot is available for use.



Bright and sharp

FL glass and high light transmission ensure image brightness with optimum target resolution – the prerequisites for a perfectly placed shot.

Robust and reliable

The extremely robust construction and reliably engineered mechanical systems guarantee safe and sure functioning under all conditions. Quality: 'Made in Germany'.



V6 2.5–15×56

With the highest light-gathering power, the Conquest V6 is an excellent choice for stand hunting and, thanks to the optional BDC (ASV), is also ideal for long-range shots. The minimum coverage of the target by the illuminated reticle ensures a perfect aim.



V6 1.1–6×24

Its wide field of view is ideal for keeping everything in sight on driven hunts. A maximum magnification factor of 6.5x guarantees the flexibility required when hunting and intuitive handling ensures quick responses.



V6 2–12×50

This compact and versatile riflescope is a reliable companion in every hunting ground. The extremely fine illuminated dot and high magnification range of the Conquest V6 2–12×50 bring high performance well into the twilight hours.



V6 3–18×50

The lightweight and lean design of this versatile riflescope makes it ideal for medium to long-range shooting. It is also reliable and simple to use. A ballistic turret is available as an optional accessory. Reticle 6 and ballistic reticles ZBR-2 and ZMOA-2.



V6 5–30×50

The Conquest V6 5–30×50 offers a high magnification factor for long-range shots. In addition to this, it also features a wide zoom range that guarantees maximum flexibility. A further advantage is its lightweight construction and lean design. Ballistic reticles ZBR-1/ ZMOA-1, and additional Reticle 43 are available.

HIGH-QUALITY OPTICS FOR **EVEN THE HARSHTEST HUNTING CONDITIONS:** ZEISS CONQUEST V4

Ballistic reticle

The ballistic reticle enables fast elevation and crosswind corrections.

Ballistic turret

The large bullet drop compensation range of the ballistic turret provides the flexibility hunters need for a wide range of hunting needs.

Functional mechanical systems

Absolute reliability: the mechanical systems stand the test in all situations where hunters need to react on the spur of the moment.



V4 1-4x24

Proven to be exactly the right riflescope for hunting at short range and in situations where fast target acquisition is essential.



V4 4-16x44

The balance between its wide field of view and magnification range make this compact riflescope ideal for all types of hunting.



V4 6-24x50

Offering 24x magnification and parallax compensation, this riflescope is the specialist for precision shooting.



V4 3-12x56

This riflescope is suitable for stand hunting and for long-range shots. The large objective lens diameter and illuminated reticle guarantee aiming accuracy, even in unfavourable light.

OPTICAL EXPERTISE

Reticles for ZEISS riflescopes

ZEISS raises the standards time and time again with the incomparably high level of precision of its new reticles.

Non-illuminated standard reticle

Non-illuminated reticles are versatile and precise. They are ideal for use when hunting in very good light, in the early hours of dusk or the later hours of dawn. A further advantage is that non-illuminated reticles can be used for measuring distances: the fine scales on the horizontal and vertical crosshairs between the reticle posts enable the determination of useful information about the distance to the game. As certain reticles have extremely fine crosshairs that obscure very little of the target or game at long ranges, non-illuminated reticles also bring distinct advantages for sports marksmen.

Illuminated reticles

Depending on the brightness of the illuminated dot or cross, there are two fundamentally different types of illuminated reticle in the ZEISS riflescope range.

In the case of versions with a very bright illuminated dot, these are referred to illuminated reticles ideal for daylight use and for use during twilight. These are found, for example, in the Victory HT models, and are particularly effective for rapid target acquisition when hunting moving game. The second group of illuminated reticles from ZEISS is intended for use in the twilight hours. The corresponding Classic and Victory FL models feature finely dimmable illuminated dots. These enable ideal adjustment to the widely varying lighting conditions encountered in the early hours of twilight. If the illuminated dot or cross were too bright, flare would obscure the target in deep twilight. These illuminated reticles therefore provide an option for optimum adjustment of the brightness – either manually or automatically with the help of the riflescope.

ACCESSORIES



BDC (ASV) for Conquest V6

BDC (ASV) for elevation can be ordered separately for retrofitting



Throw lever for Conquest V4 and V6

For fast magnification changes when speed is a critical factor.

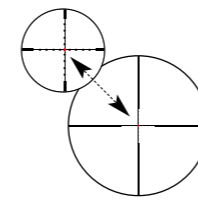

Reticle 43
With central illuminated dot
For Victory V8

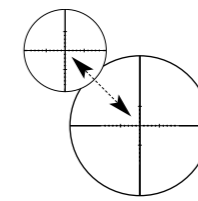

ZMOA-2
For Conquest V6

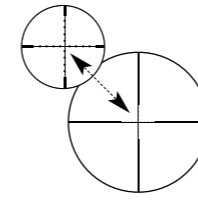

Reticle 43
Non-illuminated for Conquest V6

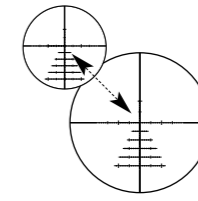

ZBR-1
For Conquest V6

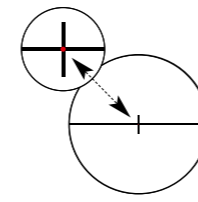

Illuminated reticle 54
For Victory V8

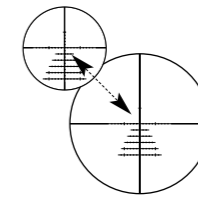

ZBR-2
For Conquest V6

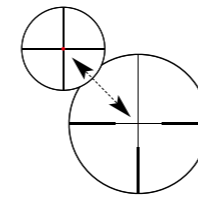

Illuminated reticle 60
For Victory V8, HT
and for Conquest V6

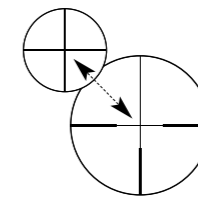

Reticle 6
For Conquest V6

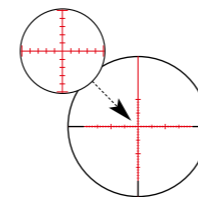

ZMOAi
For Conquest V4

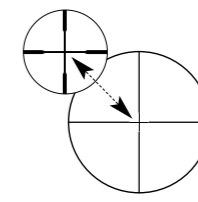

Reticle 20 (Z-Plex)
For Conquest V4

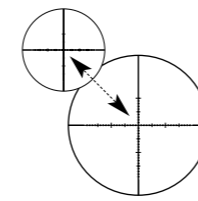

ZMOA-1
For Conquest V6, Conquest V4

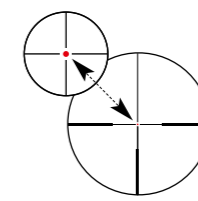

Reticle 60
For Conquest V4





BINOCULARS FROM ZEISS

VIEWED OVER TIME: THE BEST

The optical performance, outstanding ergonomics, rugged construction and the ongoing innovations with which the limits of the technically possible have been continuously expanded make binoculars from ZEISS true legends that are handed on from generation to generation.

In many cases, it is not only the passion for hunting that is passed on to the next generation of young hunters, but also dependable hunting companions in the form of ZEISS binoculars. This is made possible by the robust construction that makes the glasses reliable partners for decades to come. This is what ZEISS quality means.

This legendary quality delivers the right optical products for all hunting needs. From special binoculars for stand hunting at night to perfect all-round glasses for everyday situations. But however much the various binoculars may differ in their specialisation and performance – they all have one thing in common: the trust of numerous generations of hunters in the ZEISS brand.

Our online product guide will lead you step by step to the perfect ZEISS binoculars for your specific needs:
www.zeiss.com/productadvisor-hunting



YOU CAN NOW TAKE A CLOSER LOOK AT THEIR QUALITIES
WHAT MAKES OUR BINOCULARS UNIQUE, AND HOW ARE THEY CONSTRUCTED?
THE ZEISS AR SPORTS OPTICS APP PROVIDES THE ANSWERS.



ZEISS

ZEISS VICTORY BINOCULARS

FOR CONFIDENT, FARSIGHTED DECISIONS

Do you discover and recognise new perspectives where others see only limits and give up? Do you demand only the best from yourself, and accept nothing less? Do you enjoy having the freedom to make confident decisions? If all this applies to you, you simply can't ignore ZEISS Victory binoculars for your hunting needs.

Anyone who has ever held a ZEISS model in their hands will never want to hand it back. For almost countless good reasons. Even the tiniest details are thought-through to perfection. Innovative optical and mechanical systems interact with ergonomics with the ultimate perfection of a winning team to deliver the viewing image you need at the decisive moment. Sharp, precise, clear, uncompromising. Even

in the most unfavourable conditions. At the same time, ZEISS binoculars are amazingly robust.

With a ZEISS model in your hands, you have everything in view and remain in perfect control of the situation, however unexpected or unusual it may be. Whether in the darkest hours of twilight or at the most extreme ranges. Whether lying in wait for the stag of your life or hunting game in mountainous terrain. Any ZEISS binoculars will soon become an invaluable companion. Regardless of whether you choose an all-rounder like the Victory SF, a specialist like the Victory HT or the particularly compact Victory Pocket. They all offer you the chance to collect unique insights and personal experiences that will become treasured memories.

FACTS:

Intelligent innovations for exceptional results:

Triple-link bridge:

Constructional stability and robustness that stands up to even the harshest conditions.

Ultra-FL lens system:

Ensures natural colour fidelity, high contrast and finest detail rendition.

Magnesium materials:

The combination of extremely lightweight and high strength materials guarantees quality that lasts for generations.

LotuTec® coating:

The dust, dirt and water-repellent coating guarantees a permanently clear view.

ErgoBalance concept:

Perfectly balanced weight distribution guarantees fatigue-free observation.

ZEISS FieldFlattener technology:

Extreme edge sharpness, even with wide fields of view.

Smart Focus concept:

Optimum location of the focusing wheel ensures intuitive, fast and precise focusing.

Unique carrying comfort

Very lightweight, excellent grip characteristics

Top of the class

Extremely wide-angle fields of view

Precise and intuitive handling

Rapid focusing

Best image quality

Bright, high-contrast image, natural colour fidelity



PRODUCT PORTRAIT

THE MOST VERSATILE PREMIUM BINOCULARS IN THE HISTORY OF ZEISS: ZEISS VICTORY SF

Experience the most exciting moments of hunting as never before – with the Victory SF from ZEISS.

The ZEISS Victory SF is the most versatile premium binocular model in the 170-year history of ZEISS. Its optical perfection, unrivalled field of view, revolutionary ergonomics and featherweight construction make the Victory SF the perfect all-rounder. In this, it expresses everything ZEISS stands for – an unequalled example of leading-edge optics.

ErgoBalance concept

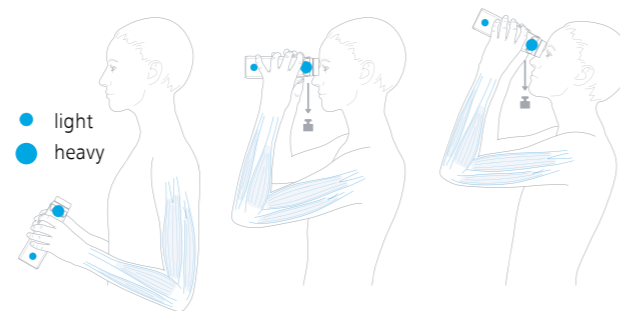

Thanks to the ErgoBalance concept, the binoculars are ideally balanced in the hands and enable prolonged and steady observation with minimum fatigue by reducing stresses on the muscles of the upper and lower arms.

Ultimate ergonomics and handling

The perfect ergonomics and ruggedness provided by its TripleLink Bridge and lightweight construction with modern magnesium alloys are the basis for effortless observation and a previously unseen viewing experience.

Fantastic handling

The Smart Focus concept and the optimum location of the focusing wheel guarantees a pin-sharp viewing image in seconds.



An exceptional viewing experience

The Ultra-FL lens system guarantees natural, true-to-life colour rendition, a bright viewing image and finest resolution of details. The use of SCHOTT HT glass in the optical system guarantees the high transmission value of 92 per cent.

Superior vision

Incomparably broad fields of view provide a perfect overview in difficult terrain and a close focus distance of 1.5 metres allows detailed exploration of the immediate vicinity.

SCHOTT
HT GLASS



PRODUCT PORTRAIT

TURNING SENSE INTO **CERTAINTY:** ZEISS VICTORY RANGEFINDER SYSTEM

Experienced hunters can always rely on their senses. Nevertheless, with the right equipment, they can go further than this and transform intuitions into certainties.

The Rangefinder System is a laser rangefinder with an integrated real-time ballistics computer. The consideration of

all relevant factors and customisation with the aid of the ZEISS Hunting App ensures precisely placed shots at any distance.

The RF family offers a choice of four models: the RF 8×42 and 10×42 for daylight hunting and the RF 8×54 and 10×54 for hunting into the twilight hours.



THE ZEISS HUNTING APP

Entirely new possibilities

The capabilities of the rangefinder system are perfected by the ability to synchronise it with the ZEISS Hunting App via Bluetooth. This allows the hunter's own ballistics data to be transferred to the rangefinder for configuration of the system.

- News**
- Hunting diary**
- My products**
- Dashboard**
- Weather forecast**
- Hunting grounds**
- Ballistics**
- Connected products**



All the relevant factors

The ability to save up to nine personalised ballistic profiles set up in the ZEISS Hunting App guarantees perfect adaptation to the hunter's needs.



Binocular real-time ballistics system

The various measuring functions of the rangefinder take a multitude of relevant data into account and use them to calculate the precise setting for the BDC (ASV) in all environmental conditions.



Ultimate performance at the cutting edge of technology

At ZEISS, we are never satisfied with the status quo. The software of the RF is being constantly revised and updated to further improve its performance. Bluetooth connectivity and our ZEISS Hunting App enable you to keep your rangefinder at the cutting edge of software developments.

All you need at a glance

The rangefinder determines the precise target distance up to a maximum range of 2,300 metres.



PRODUCT PORTRAIT

MADE FOR THE TWILIGHT HOURS: ZEISS VICTORY HT 54

The day's hunting doesn't end as soon as the sun goes down. With the right equipment, it can easily continue into the hours of twilight. ZEISS developed the Victory HT models for precisely this situation.

Victory HT premium binoculars let you experience an entirely new dimension of hunting. Thanks to a revolutionary optical concept, they bring spectacular transmission values of 95 per cent and more. An exceptional value – that is achieved by the perfect combination of SCHOTT HT glasses, ZEISS T* multi-layer coating and an Abbe-König prism system and ensures maximum brightness. This means that you are able to observe your surroundings when hunting for much longer – even in the latest hours of twilight. Equally innovative: the ergonomics. The new ComfortFocus Concept impresses with a large focusing wheel that is embedded in the double-link bridge. This makes it extremely robust, ensures easy handling and also guarantees a long service life. Experience the absolute pinnacle of leading-edge optics – with the brightest ever binoculars from ZEISS.

INNOVATIONS FROM ZEISS



LOTUTEC® – a clear view, whatever the weather

There are always exciting things to be seen in the world of nature – even in wet weather. This is why ZEISS developed LotuTec®. A coating for the lenses of binoculars and spotting scopes that enables a clear and unhindered view in all weather conditions.

Tradition revisited

The elegant design is the continuation of the design concept of the ZEISS Dialyt – timeless and functional.

Form follows intuition

The large focusing wheel of the Comfort Focus concept ensures superior handling ergonomics, even when wearing gloves.



Built to last a lifetime

The use of magnesium alloys combining light weight with high rigidity guarantees a long and reliable service life.

A brighter outlook

The ZEISS Victory HT is not simply bright: the integration of FL lenses increases its resolving power and brings outstanding brilliance to the viewing image. This ensures an ideal viewing experience in all lighting conditions.



RF 8/10x42

The compact rangefinder model. The binocular real-time ballistics system can be synchronised with the Hunting App via Bluetooth.



RF 8/10x54

All the qualities of the rangefinder system in combination with powerful optics. The model for users who look for the best when it comes to optical performance.



SF 8/10x42

With a value of 148 metres at 1,000 metres, the field of view of these binoculars is absolutely outstanding. Thanks to the Smart Focus concept, the outstanding optical performance is also complemented by perfect ergonomics.



HT 8/10x54

The models with the 54-millimetre objective lens are among the most powerful night-hunting binoculars from ZEISS. With a light transmission of 95 per cent, these binoculars guarantee maximum performance in the hours of dusk and dawn. At the same time, the 8x54 impresses with outstanding ergonomics and a large exit pupil.

ZEISS FL BINOCULARS – for finest detail resolution

Thanks to the use of special fluoride glasses in the optical system, chromatic aberrations are considerably reduced.



FL 8/10x32

The special lenses with FL glasses minimise colour fringing, ensure superior edge sharpness and thus leads to a sharp viewing image with the finest resolution of details. In addition to this, the compact size and low weight make them ideal for prolonged observation.

With FL glass



The FL glass minimises the dispersion of the colour spectrum. This results in greater colour fidelity, contours that are practically free from chromatic aberration and outstanding resolution of the finest details.

Without FL glass



When using standard glasses, the spectrum of the light entering the optical system is split into its component colours. This results in chromatic aberration, an effect that reduces the sharpness and contrast of the viewing image.

ACCESSORIES



Air Cell Comfort carrying strap

The carrying strap enables binoculars with lens diameters greater than 30 millimetres to be carried much more comfortably. Embedded air cells make the strap very comfortable to wear, while quick-release fasteners make it easy to attach and remove. The strap length can be adjusted to meet the user's needs.



Comfort carrying harness

Made from premium materials, the harness prevents neck strain and distributes the weight of the binoculars over the upper body. When moving around, the binoculars remain steady and any uncontrolled swinging is prevented. The harness offers outstanding carrying comfort and enables binoculars to be quickly and easily fixed when not in use.

THE COMPACT COMPANION: ZEISS VICTORY POCKET.



Pocket 8/10x25

Proven high-performance binoculars for virtually all observation situations. The compact size and light weight allow them to be conveniently carried in smaller jacket pockets when not in use.

Light

Lightweight qualities and asymmetric folding make this model particularly handy to carry anywhere.

Modern

The design, the mechanical system and the robustness of these binoculars fulfil the highest expectations.

Brilliant

Broad field of view and FL glass for a particularly sharp and richly detailed viewing image.



REAL-LIFE HUNTING OPTICS

OUT IN THE FIELD IN ALL WEATHERS



Absolute confidence in every situation. Environmental considerations, terrain or lighting conditions – just a few of the ever-present challenges encountered when hunting.

This is why all of our products are subjected to a range of exhaustive tests to ensure that they fulfil the demands of everyday hunting scenarios. With the optical excellence, outstanding ruggedness and perfect ergonomics from ZEISS, you are ideally equipped for every situation and live up to even the most stringent expectations.

Anette Dahl

Anette grew up on an idyllic dairy farm in Norway. She was only five when her father first took her with him on a moose-hunting trip. She was hooked from this moment on. In the years that followed, she accompanied her father to the hunting grounds as often as she could and learned to hunt from the ground up. Today, Anette works as a teacher of physical education, hunting, wildlife and forestry, owns her own hunting ground and, whenever possible, can be found roaming the wild with her dogs – in every wind and weather.

Follow Anette on Instagram:
[@dahl.anette](#)

Marius Elpers

For Marius, hunting is a family tradition. Many generations of the Elpers family have hunted in the beautiful countryside of the Münsterland region of Germany. Marius is no exception, and qualified for his hunting licence at the age of 17. Marius' passion for hunting takes him far beyond the borders of his home hunting grounds: 'I have a constant urge to travel abroad and learn about new kinds of game and local hunting traditions.' He shares his passion and experiences in various media, including his YouTube channel 'WildboarFanatic'.

Follow Marius on Instagram:
[@wildboarfanatic](#)

PERFECT ALL-ROUNDERS: ZEISS CONQUEST HD

Nature in HD

The highest resolution of details and natural colour rendition of the HD lens system lets you experience new standards of optical excellence.

Perfect balance

Compact dimensions, low weight and modern design come together to create exemplary ergonomics and result in an intuitive and simple handling concept.

Light in the darkness

High transmission values are an essential prerequisite for impressive observation in the twilight hours.



HD 8/10×32

Thanks to the extra-wide field of view of the HD lens systems, compact dimensions, low weight and carrying comfort, the Conquest HD 8/10×32 is the ideal, high-performance companion for every situation.



HD 8/10×42

Exceptional quality and performance – Made in Germany. Ideal for users who are looking for sharpness, high resolution of details, natural colour rendition and outstanding quality in the close focusing range.



HD 8/10/15×56

This version is the specialist for situations in unfavourable light and impresses with a bright, high-contrast viewing image. The 15×56 is supplied complete with a tripod adapter.

ZEISS IN PRACTICE



Care and cleaning tips from ZEISS

LotuTec® is a resilient and abrasion-resistant lens coating with a special surface and strong lotus effect that reduces the adhesion of water droplets and dirt on lenses. The use of a ZEISS lens cleaning cloth is recommended for cleaning lens surfaces. Coarse dirt on lenses – for example, sand, mud or soil – must not be wiped off: it should only be removed by rinsing with clear water or with a clean lens brush with soft, fine bristles.

PERFECT FOR EVERY TRIP: ZEISS TERRA ED

Ergonomic

Focusing with a ZEISS Terra ED is made particularly quick and easy by the smooth action of its large, intuitively placed focusing wheel.



Compact, light and robust

The glass-fibre-reinforced, waterproof casing of the ZEISS Terra ED resists even the toughest outdoor situations.

Proven excellence

The use of SCHOTT ED glass and hydrophobic multicoating of exposed lens surfaces fulfils the highest optical demands.



ED Pocket 8/10x25

In its class, the extremely light and compact Terra ED Pocket delivers an outstanding viewing experience and impresses with intuitive handling.



ED 8/10x32

Impressive images, precise focusing and compact size are the characteristic features of the 32-millimetre version of the Terra ED.



ED 8/10x42

A bright image, outstanding resolution of details and comfortable viewing characteristics. In combination with optimum ease of handling, these perfectly describe the outstanding properties of the Terra ED 42.

ZEISS IN PRACTICE



Always ready for action also means use under the most extreme conditions. This is why ZEISS pays particular attention to the use of premium materials in the construction of its latest optical products. The binoculars and spotting scopes are of course fully sealed against moisture and nitrogen-filled to ensure that no internal fogging can occur, even in rapidly changing temperatures. The rubber armouring makes the glasses robust and impact-resistant, and provides a first line of protection for the high-performance optical systems inside. This all contributes to optical products you can always trust and rely on.

OPTIMUM VISIBILITY, EVEN IN THE LIGHT OF A NEW MOON: ZEISS VICTORY NV

Superior image intensifier tube

The intensifier tube with a light amplification factor of around 20,000 contains a microchannel plate (MCP) for the generation of sharp, finely detailed images in the hours of darkness.

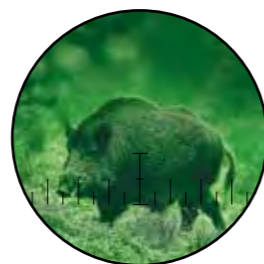

Robust construction

The optical and mechanical systems are effectively protected against environmental influences by the waterproof, rubber-armoured, nitrogen-filled casing.

Perfect interplay

Available light is gathered by the 62-millimetre objective lens and focused on the extremely sensitive photocathode.



ZEISS Mono

The 3×12 is a powerful mini-telescope with 3× magnification. It transforms Victory* and Conquest binoculars with objective lens diameters of more than 30 millimetres and more and the Dialyt 8×56 GA into high-performance spotting scopes at the flick of a wrist by attaching it to the eyepiece with an adapter ring. Can also be used separately as a magnifier in the close focus range.

* Not SF



ZEISS Mono

For a precisely detailed view at sporting events, in the theatre or at longer distances outdoors: The Monos with ZEISS T* multicoating impress with a bright and clear viewing image and, depending on the model, can also be used as magnifiers.



20×60 S

Superlative binoculars in every respect: developed for the longest distances, and even used on missions to the International Space Station (ISS). The exceptional light transmission of the Porro prism system guarantees the brightest viewing images with outstanding resolution of the finest details even at 20× magnification. The technically unique mechanical image stabilisation system of the 20×60 T* S ensures a perfect viewing experience: the unavoidable shake always encountered when observing with handheld binoculars can be easily eliminated at the press of a button.



5.6×62 NV

State-of-the-art image intensifier tubes amplify even the lowest levels of light to make the game observed appear 20,000 times brighter. In the complete absence of light or residual light, the integrated IR-LED can be activated at the touch of a button. The LED radiates light in the infrared spectrum and allows observation with the NV device at distances of around 50 metres. By attaching a torch with an IR filter, illumination can be extended to several hundred metres.

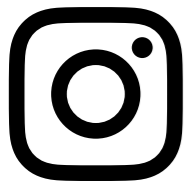
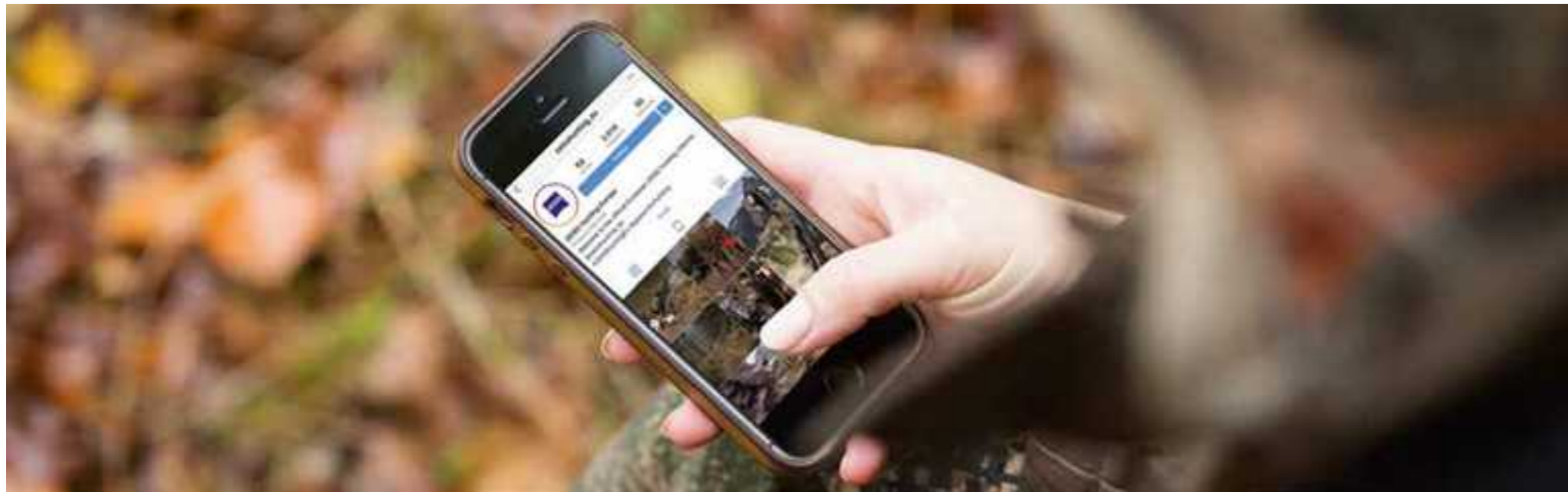

#ZEISShuntingEU

EXPERIENCE HUNTING IN EUROPE



FOLLOW ZEISShunting_EU ON INSTAGRAM

SIMPLY OPEN YOUR INSTAGRAM APP AND GO TO THE SEARCH 🔍 FUNCTION. YOU WILL FIND THE INSTAGRAM NAME TAG SYMBOL (🏷️) AT THE TOP RIGHT OF THE APP. USE IT TO SCAN THE NAME TAG DISPLAYED HERE AND START FOLLOWING ZEISSHUNTING_EU RIGHT AWAY.

The ZEISShunting_EU channel on Instagram is packed with exciting content from the world of hunting. It presents a wide range of hunting traditions alongside details of Europe's most inspiring hunting regions. The channel also offers useful and practical hunting tips and regional recipes for game – always from hunters for hunters.

This is an absolute must for everyone with a passion for hunting: experienced hunters like Anette Dahl, Paul Childerley or David Carsten Pedersen invite you to share one exciting live hunting trip after another on their travels across Europe.

Share your hunting experiences

Simply tag your Instagram pictures with #ZEISShuntingEU and take advantage of the opportunity to be published on the ZEISS channel along with your snapshot.

Become a part of the #ZEISShuntingEU community and discover the hunting spirit of Europe at first hand.

Experienced hunters take you along on their hunting trips in Instagram Stories.

Follow ZEISS on Instagram and experience hunting in Europe.

Tag your pictures with #ZEISShuntingEU and share them with the community. Discover Europe's most breathtaking hunting regions.

Write a message to ZEISS Hunting with the 'Direct Message' function. We always welcome your questions and feedback.

Visit the gallery for the latest information on all ZEISS products.

What would a hunting trip be without what comes before and after it? Find exclusive tips and the best European recipes for game.





SPOTTING SCOPES FROM ZEISS

WHEN RELIABILITY MEETS FASCINATION

On the one side, curiosity and open-mindedness, on the other, high-tech spotting scopes from ZEISS. When these come together, encounters with the world of nature become unique experiences – every time.

Nature is all around us, and is fascinating in all weathers – in extremes like the Arctic and the Amazon basin, as well as close to your home. This is why so many people have discovered their passion for observing wildlife and the world of nature. For this, they need equipment with guaranteed reliability at all times.

Spotting scopes from ZEISS fulfil these needs in a variety of ways – with outstanding brightness and contrast, the finest rendition of details, wide fields of view and stunning

magnification. Fast and exact focusing on a subject and precise, fine focusing adjustment guarantee discerning wildlife watchers certain identification of their targets at long distances. At the same time, the high-quality products from ZEISS are characterised by a ruggedness that guarantees reliability in even the toughest conditions.

Around the world and every day, all of this makes ZEISS spotting scopes firm favourites that enable people to get a better and closer view of nature than ever before. No matter whether you are watching the migration of enormous herds of animals or the trajectory path of a single bird.

Our online product guide will lead you step by step to the perfect ZEISS observation optics for your specific needs: www.zeiss.com/productadvisor-hunting



YOU CAN NOW TAKE A CLOSER LOOK AT THEIR QUALITIES

WHAT MAKES OUR SPOTTING SCOPES UNIQUE, AND HOW ARE THEY CONSTRUCTED?
THE ZEISS AR SPORTS OPTICS APP PROVIDES THE ANSWERS.



ZEISS VICTORY SPOTTING SCOPES

A NEW VISUAL DIMENSION

The Victory Harpia is a true ZEISS model in every respect – absolutely premium optics, proven ruggedness and ergonomics meet state-of-the-art technology.

This spotting scope features the DualSpeed Focus system with fast switching from close to long ranges and options for fine focusing and sharpness correction.

One of the many innovations of this high-performance spotting scope from ZEISS is that magnification and focusing are controlled with collars on the body of the scope and not, as usual, with the

eyepiece. This enables very fast adaptation to the current situation and brings dedicated birdwatchers and wildlife enthusiasts even more fascinating encounters with the world of nature.

Further unquestionable benefits are the 72° field of view and the respective, model-specific close-focus distances of 3.5 and 4.5 metres. These values make the Victory Harpia ideal for observation on a larger scale, for example, by lakes or in woodland – as well as at closer ranges.

FACTS:

Intelligent innovations for exceptional results:

FL glass:

Natural colour fidelity, high contrast, brilliance and the finest detail rendition.

LotuTec® coating:

The dust, dirt and water-repellent coating guarantees a permanently clear view.

Dual Speed Focus:

Precise focusing with automatic switch between fast and fine-focusing drive.

Magnesium materials:

The combination of extremely lightweight and high strength materials that last for generations.

High magnification factors

Sharp image for precise long-range target identification

Optimum performance

Objective lens diameters of up to 95 millimetres for clear and bright images with razor-sharp details

Outstanding ergonomics

Large operating elements with smooth action for fast and precise focusing



PRODUCT PORTRAIT

THE MOST POWERFUL SPOTTING SCOPE FROM ZEISS: **ZEISS VICTORY HARPIA**

The world of nature is already truly fascinating when observed with the naked eye. But viewing it through a Victory Harpia transforms into an entirely new experience.

This spotting scope offers a new and unusual optical system with a 3x wide-angle zoom, up to 70x magnification and choice of 85 and 95 mm objective lens diameters. The extremely wide fields of view bring impressive results in every situation. DualSpeed Focus enables fast focusing and easy, precise, fine focus adjustment, even at high magnification factors.

Thanks to its unique, 72° wide-angle field of view throughout the entire 3x zoom range, the unrivalled dynamic of the Victory Harpia guarantees superior performance at long or short distances in every unexpected viewing situation.

ComfortVision Concept

A subjective viewing angle of 72° throughout the entire zoom range for a noticeably broader overview of the terrain.



ZEISS Victory Harpia

Comparison of the field of view of a spotting scope with 30x min. magnification (small circle) with the field of view of the Harpia at 23x min. magnification (large circle).

Compact, high-performance eyepiece

Slim construction for a comfortable viewing experience. Securely lockable bayonet mount.

DualSpeed Focus

Automatic switch between fast- and fine-focusing drive for fast and precise focusing.



LotuTec® coating

A clear view in all weather conditions. Raindrops and dirt simply roll off the lens.



Harpia 95

The unusual optical system features a 3x wide-angle zoom, up to 70x magnification and an objective lens diameter of 95 millimetres. The extremely wide fields of view prove their worth in every situation. The Harpia 95 also features precise focusing with convenient automatic transition from rapid to fine adjustment, even at high magnification factors.



Harpia 85

With the exception of its objective lens diameter of 85 millimetres, this version offers the same overall advantages as the Harpia 95. Thanks to the use of FL glasses and other specially formulated glass types, the Harpia 85 also delivers an absolutely sharp viewing image with natural colour fidelity, even at maximum magnification. And a subjective angle of view of 72° throughout the entire zoom range provides a noticeably greater overview of the terrain.



ACCESSORIES



Tripod Professional

The ZEISS Tripod Professional fulfils the most demanding requirements with regard to compatibility and loading weight and enables particularly smooth panning and tilting. It is specifically suitable for use with our Victory products and for digiscoping.



Long Balance Plate

Our Long Balance Plate is the ideal solution to perfectly balance your spotting scope, especially when digiscoping. (only for Tripod Professional).



Ever-ready carrying case for the Victory Harpia

The case offers reliable protection against all kinds of weather and wet conditions, is comfortable to carry and enables fast readiness of the spotting scope for use. The caps for the eyepiece and the objective lens can be securely attached to the case to prevent loss.



ZEISS photo adapter

Whether for still pictures or film, the photo adapter (for M49, M52 or M58 filter threads) enables direct attachment of a digital camera to the Victory Harpia and transforms the spotting scope into a powerful tele lens.

THE EXPLORER'S COMPANION: ZEISS CONQUEST GAVIA 85



Ergonomic

The large focusing ring enables precise handling and easy focusing of the viewing image.

Light

The magnesium body and compact dimensions make the Gavia a lightweight and handy companion wherever you go.

Bright, clear and richly detailed

Exceptionally precise roof prisms and an HD lens system guarantee a bright and clear viewing image.



Gavia 85

This spotting scope with an 85-millimetre objective lens is particularly lightweight and compact. This makes it the ideal instrument for close- and long-range observation, especially in regions that are difficult to access. Unique in this class is the short close-focus that enables problem-free acquisition of small targets.

ACCESSORIES



Ever-ready carrying case for the Conquest Gavia

Developed especially for the Conquest Gavia, the case protects the spotting scope against environmental influences such as moisture and dirt. In addition to this, optimum carrying comfort, fast readiness of the spotting scope for use and an option for attaching the eyepiece and objective lens cap to the case make it an invaluable part of the equipment.

ZEISS IN PRACTICE



Simple stepping rings allow the ZEISS photo adapter to be mounted on lenses with other filter thread sizes. Due to their lightweight properties, MFT (Micro-Four Thirds) cameras with prime lenses between 17 and 25 millimetres are particularly suitable for digiscoping. APS-C cameras with suitable lenses, for example the Sony ZEISS 2.8/35 mm, also allow photography with all magnification ranges of the spotting scope.

1.25" astro adapter

For mounting standard astro eyepieces.



ZEISS photo adapter

Whether for still pictures or film, the photo adapter (for M49, M52 or M58 filter threads) enables direct attachment of a digital camera to the Conquest Gavia 85 and transforms the spotting scope into a powerful telephoto lens.



THE IDEAL HUNTING COMPANION: ZEISS DIALYT

High performance

Fascinates with a richly detailed viewing image and features 45x magnification for identification of objects at extreme distances.

Versatile

A bright, clear and richly detailed viewing image into the twilight hours for an optimum overview in all weathers and at any distance.



Light

The compact monobloc construction makes the Dialyt the ideal companion for stalking and stand hunting.



Dialyt

The light and compact 'hunter's spotting scope' was developed especially for fast and precise target identification at extreme distances. A waterproof, non-fogging, construction, reliable functioning and simple handling make it the ideal companion for hunting in flat, open country or in rugged mountainous terrain.

ACCESSORIES

Tripod mount

The Dialyt 18-45x65 can be rested on a rucksack or supported against a tree trunk for steady viewing and also features a field-tested tripod mount. In the case of a lack of natural support, or for longer periods of observation, it is advisable to mount the spotting scope on a carbon tripod from ZEISS. Another alternative would be the use of a lightweight monopod for support.



A DIVERSITY OF DEVELOPMENTS: ZEISS RIFLESCOPES

Victory riflescopes	V8				
Model	1.1-8x30	1.8-14x50	2.8-20x56	4.8-35x60	
Magnification	1.1-8x	1.8-13.5x	2.8-20x	4.8-35x	
Effective lens diameter	10.6-30 mm	18.6-50 mm	27.5-56 mm	48.1-60 mm	
Exit pupil diameter	9.9-3.9 mm	10.3-3.7 mm	9.8-2.8 mm	9.9-1.4 mm	
Twilight factor	3.1-15.5	5.1-26	7.9-33	13.6-45.8	
Field of view at 100 m	39.6-5.4 m	23-3.1 m	15.5-2.1 m	8.6-1.2 m	
Objective viewing angle	22.2°-3°	13.1°-1.8°	8.9°-1.2°	4.9°-0.7°	
Diopter adjustment range	-3.5/+2 dpt				
Eye relief	95 mm				
Parallax free	100 m	50 m-∞			
Vertical adjustment range at 100 m	500 cm	310 cm	210 cm	130 cm	
Lateral adjustment range at 100 m	320 cm	200 cm	135 cm	85 cm	
Adjustment per click at 100 m	1 cm			0.5 cm	
Centre tube diameter	36 mm				
Eyepiece tube diameter	46 mm				
Objective tube diameter	36 mm	56 mm	62 mm	67 mm	
LotuTec®/Nitrogen filled	yes/yes				
Water resistance	400 mbar				
Operating temperature	-25°C/+50°C				
Length	303 mm	343 mm	350 mm	402 mm	
Illuminated reticles	54, 60	60	60	43, 60	
Weight with illuminated reticle	without inner rail with inner rail	600 g 620 g	710 g 730 g	830 g 855 g	970 g 1,000 g
Part number (XXXXXX-XXXX-XXX)	without inner rail with inner rail	52 21 07- 52 21 06-	52 21 17- 52 21 16-	52 21 37- 52 21 36-	52 21 47- 52 21 46-
Choice of illuminated reticles (xxxxxx-XXXX-xxx)	43 54 60	- -9954- -9960-	- - -9960-	- - -9960-	-9943- - -9960-
Bullet drop compensator (ASV) (xxxxxx-xxxx-XXX)	without BDC BDC (elevation) BDC (elev. and windage)	-000 - -	-000 -040 -050	- -040 -050	- -040 -050
		-	BDC (ASV) LR	BDC (ASV) LR	BDC (ASV) Comp.

Example for a complete order number for Victory V8 1.8-14x50 with inner rail, ret. 60, ASV LR (elevation): 522116-9960-040
Subject to changes in design and scope of delivery as a result of ongoing technical development.

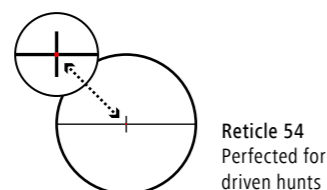
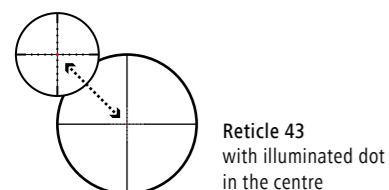

Victory riflescopes	HT		
Model	2.5-10x50	3-12x56	
Magnification	2.5x-10x	3x-12x	
Effective lens diameter	37.7-50 mm	44-56 mm	
Exit pupil diameter	15-5 mm	14.9-4.7 mm	
Twilight factor	7.1-22.4	8.5-25.9	
Field of view at 100 m	14.8-4.1 m	12.5-3.5 m	
Objective viewing angle	8.5°-2.3°	7.2°-2°	
Diopter adjustment range	-4/+2 dpt		
Eye relief	90 mm		
Parallax free	100 m		
Vertical adjustment range at 100 m	140 cm	120 cm	
Lateral adjustment range at 100 m	140 cm	120 cm	
Adjustment per click at 100 m	1 cm		
Centre tube diameter	30 mm		
Eyepiece tube diameter	42 mm		
Objective tube diameter	56 mm	62 mm	
LotuTec®/Nitrogen filled	yes/yes		
Water resistance	400 mbar		
Operating temperature	-25°C/+50°C		
Length	321 mm	347 mm	
Illuminated reticles	60	60	
Weight with illuminated reticle	without inner rail with inner rail	525 g 550 g	573 g 598 g
Part number (XXXXXX-XXXX-XXX)	without inner rail with inner rail	52 21 25- 52 24 24-	52 24 35- 52 24 34-
Choice of illuminated reticles (xxxxxx-XXXX-xxx)	43 54 60	- - -9960-	- - -9960-
Bullet drop compensator (ASV) (xxxxxx-xxxx-XXX)	without BDC BDC (elevation) BDC (elev. and windage)	-000 -010 -020	-000 -010 -020
		BDC+ (ASV+)	BDC+ (ASV+)

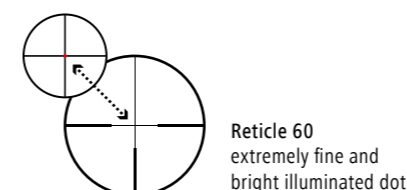

Conquest riflescopes		V6				
Model		1.1–6×24	2–12×50	2.5–15×56	3–18×50	5–30×50
Magnification		1.1–6.5×	2–12×	2.5–15×	3–18×	5–30×
Effective lens diameter		10.5–24 mm	19.4–50 mm	24.3–56 mm	28.6–50 mm	47.3–50 mm
Exit pupil diameter		9.5–3.7 mm	9.7–4.2 mm	9.7–3.7 mm	9.5–2.8 mm	9.5–1.7 mm
Twilight factor		3.1–12.5	5.7–24.5	7.1–29.0	8.5–30.0	14.1–38.7
Field of view at 100 m		38.1–6.6 m	20.5–3.4 m	16.4–2.7 m	12.4–2.1 m	7.4–1.2 m
Objective viewing angle		21.6°–3.8°	11.7°–2.0°	9.4°–1.6°	7.1°–1.2°	4.2°–0.7°
Diopter adjustment range		+2/–3 dpt				
Eye relief		90 mm				
Parallax setting		100 m	100 m	100 m	∞	∞
Square adjustment range at 100 m		300 cm	250 cm	200 cm	300 × 170 m	180 × 100 m
Adjustment per click at 100 m		1 cm			1/4 MoA (0.7 cm/100 m)	
Centre tube diameter		30 mm				
Eyepiece tube diameter		45.5 mm				
Objective tube diameter		30 mm	56 mm	62 mm	56 mm	56 mm
LotuTec®/Nitrogen filled		yes/yes			LotuTec® / ZEISS T*	
Water resistance		400 mbar				
Operating temperature		–25/+50 °C				
Length		290 mm	335 mm	352 mm	338 mm	380 mm
Weight	without inner rail	505 g	620 g	690 g	630 g	740 g
	with inner rail	545 g	655 g	725 g	not available	not available
Order number	without inner rail	52 22 05	52 22 25	52 22 35	52 22 41	52 22 51
	with inner rail	52 22 04	52 22 24	52 22 34	–	–
Choice of reticles (XXXXXX-XXXX-XXX)	60	9960	9960	9960	–	–
	20	–	–	–	9906	9906
	43	–	–	–	–	9943
	ZMOA-2	–	–	–	9994	–
	ZMOA-1	–	–	–	–	9993
	ZBR-2	–	–	–	9992	–
	ZBR-1	–	–	–	–	9991
	BDC (ASV)	–	060	060	–	–
Bullet drop compensator (ASV) (XXXXXX-XXXX-XXX)	Ballistic Turret	–	–	–	070	070

Subject to changes in design and scope of delivery as a result of ongoing technical development.

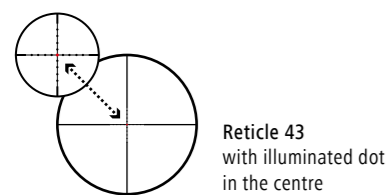

Reticle 43 with illuminated dot in the centre

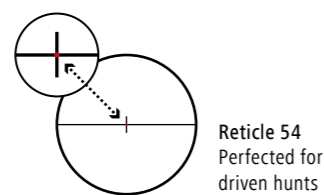

Reticle 54 Perfected for driven hunts

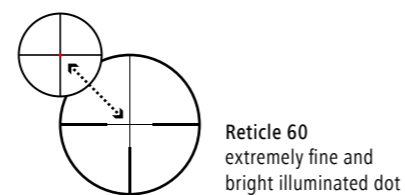

Reticle 60 extremely fine and bright illuminated dot

Conquest riflescopes		V4							
Model		1–4×24		3–12×56		4–16×44		6–24×50	
Magnification		1	4	3	12	4	16	6	24
Effective lens diameter		12.1 mm	24 mm	27.7 mm	56 mm	33.2 mm	44 mm	44.9 mm	50 mm
Exit pupil diameter		11.9 mm	6 mm	9.2 mm	4.7 mm	8.5 mm	2.8 mm	7.5 mm	2.1 mm
Twilight factor		3.5	9.8	9.1	25.9	11.5	26.5	16.4	34.6
Field of view		38 m	9.5 m	12.7 m	3.2 m	9.5 m	2.4 m	6.3 m	1.6 m
Angular field of view, real		21.5°	5.4°	7.2°	1.8°	5.4°	1.4°	3.6°	0.9°
Diopter range		+2/–3 dpt							
Eye relief		90 mm							
Parallax setting		91.4 m				45.7 m–∞			
Adjustment range at 100 m		300 cm		200 cm		230 × 175 cm		230 × 175 cm	
Adjustment per click at 100 m		1,4 cm		1/4 MoA (0.7 cm/100 m)					
Centre tube diameter		30 mm							
Eyepiece tube diameter		44 mm							
Lens tube diameter		30 mm		62 mm		50 mm		56 mm	
Coating/(LotuTec®/Nitrogen filled)		yes/yes							
Water resistance		400 mbar							
Operating temperature		–25/+55 °C							
Length		256 mm		368 mm		356 mm		368 mm	
Weight	without inner rail	470 g		610 g		640 g		690 g	
	with inner rail	–		–		–		–	
Part number (XXXXXX-XXXX-XXX)	without ill. reticle	–		522921		522931		522951	
	with ill. reticle	522905		522925		–		522955	
Choice of reticles (XXXXXX-XXXX-XXX)	60	9960		9960		–		–	
	20	–		9920		9920		–	
	ZMOA-2	–		–		9994		–	
	ZMOA-1	–		–		–		9993	
	ZMOAi-1	–		–		–		9993	
	ZBR-2	–		–		9992		–	
	ZBR-1	–		–		–		9991	
Bullet drop compensator (ASV) (XXXXXX-XXXX-XXX)	Ballistic Turret	–		–		080		080	

Subject to changes in design and scope of delivery as a result of ongoing technical development.

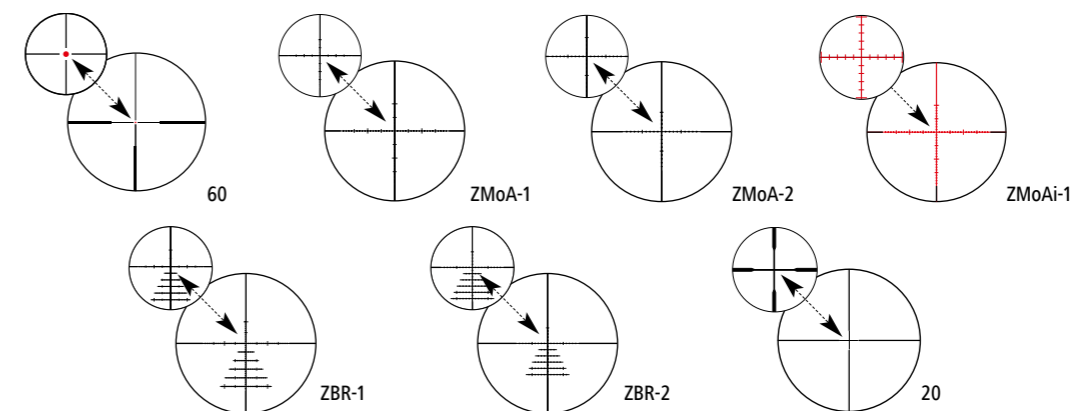

PATHFINDING SOLUTIONS: ZEISS RANGEFINDER SYSTEM AND BINOCULARS

Victory Rangefinder System Model	RF System			
	8×42	10×42	8×54	10×54
Magnification	8×	10×	8×	10×
Effective lens diameter	42 mm		54 mm	
Exit pupil diameter	5.3 mm	4.2 mm	6.8 mm	5.4 mm
Twilight factor	18.3	20.5	20.8	23.2
Field of view	135 m	115 m	120 m	110 m
Subjective angle of view	61° Ww	63° Ww	54° Ww	61° Ww
Close-up setting limit	2.5 m		3.5 m	
Diopter adjustment range	+/-4 dpt.		+/-4 dpt.	
Eye relief	16 mm		14 mm	
Pupil distance	53.5–76 mm		58.5–76 mm	
Lens type	FL			
Prism system	Abbe-König			
Coating	LotuTec®/T*			
Nitrogen filling	yes			
Waterproof	100 mbar			
Operating temperature	-25/+63 °C			
Length	166 mm		195 mm	
Width with an eye spacing of 65 mm	130 mm		141 mm	
Weight	930 g	960 g	1,095 g	1,130 g
Measuring range	10–2,300 m			
Measuring accuracy	±1 to 600/±0.5 % over 600 m			
Measuring duration	<0.3 Sec			
Laser wavelength	905 nm			
Laser beam divergence	1.6×0.5 nm			
Battery	1×3V Type CR 2			
Battery life at +20°C	>2.500×			
Order number	52 45 48	52 45 49	52 56 48	52 56 49

Subject to changes in design and scope of delivery as a result of ongoing technical development.

Victory binoculars Model	SF		HT		FL	
	8×42	10×42	8×54	10×54	8×32	10×32
Magnification	8×	10×	8×	10×	8×	10×
Effective lens diameter	42 mm		54 mm		32 mm	
Exit pupil diameter	5.3 mm	4.2 mm	6.7 mm	5.4 mm	4 mm	3.2 mm
Twilight factor	18.3	20.5	20.7	23.2	16	17.9
Field of view at 1,000 m	148 m	120 m	130 m	110 m	140 m	120 m
Subjective viewing angle	64° Ww		60° Ww	63° Ww	64° Ww	69° Ww
Close focusing distance	1.5 m		3.5 m		2 m	
Diopter adjustment range	+/-4 dpt.		+/-3 dpt.		+/-4 dpt.	
Exit pupil distance	18 mm		16 mm		15.5 mm	15.2 mm
Interpupillary distance (PD)	55–76 mm		58–76 mm		52–74 mm	
Objective type	Ultra-FL		FL/HT-Type		FL	
Prism system	Schmidt-Pechan		Abbe-König		Schmidt-Pechan	
Coating	LotuTec®/T*		LotuTec®/T*		LotuTec®/T*	
Nitrogen filled	yes		yes		yes	
Water resistance	400 mbar		500 mbar		400 mbar	
Operating temperature	-30/+63°C		-30/+63°C		-30/+63°C	
Length	173 mm		193 mm		117 mm	
Width at an interpupillary distance of 65 mm	125 mm		142 mm		116 mm	
Weight	780 g		1,035 g	1,050 g	550 g	560 g
Order number	52 42 23	52 42 24	52 56 28	52 56 29	52 32 30	52 32 31

Subject to changes in design and scope of delivery as a result of ongoing technical development. For more information, please visit www.zeiss.com/sports-optics

Victory binoculars Model	Pocket	
	8×25	10×25
Magnification	8×	10×
Effective lens diameter	25 mm	25 mm
Exit pupil diameter	3.1 mm	2.5 mm
Twilight factor	14.1	15.8
Field of view at 1,000 m	130 m	105 m
Subjective viewing angle	60°	
Close focus	1.9 m	
Diopter adjustment range	+/-3 dpt	
Exit pupil distance	16.5 mm	
Pupil distance	34–74 mm	
Lens type	FL	
Prism system	Schmidt-Pechan	
LotuTec®/Nitrogen filled	yes/yes	
Water resistance	100 mbar	
Operating temperature	-25/+63°C	
Length	112 mm	
Width at an interpupillary distance of 65 mm	100 mm	
Weight	290 g	
Order number	52 20 38	52 20 39

Subject to changes in design and scope of delivery as a result of ongoing technical development.

Conquest binoculars Model	HD						
	8×32	10×32	8×42	10×42	8×56	10×56	15×56
Magnification	8×	10×	8×	10×	8×	10×	15×
Effective lens diameter	32 mm	32 mm	42 mm	42 mm	56 mm	56 mm	56 mm
Exit pupil diameter	4 mm	3.2 mm	5.25 mm	4.2 mm	7 mm	5.6 mm	3.7 mm
Twilight factor	16	17.9	18.3	20.5	21.2	23.7	29.0
Field of view at 1,000 m	140 m	118 m	128 m	115 m	125 m	115 m	80 m
Subjective viewing angle	64° Ww	68° Ww	59° Ww	66° Ww	57° Ww	66° Ww	69° Ww
Close focus	1.5 m		2 m		3.5 m		
Diopter adjustment range	+/-4 dpt		+/-4 dpt		+/-4 dpt		
Exit pupil distance	16 mm		18 mm		18 mm		
Pupil distance	54–74 mm		54–74 mm		54–74 mm		
Lens type	HD		HD		HD		
Prism system	Schmidt-Pechan		Schmidt-Pechan		Abbe-König		
Coating	LotuTec®/T*		LotuTec®/T*		LotuTec®/T*		
Nitrogen filled	yes		yes		yes		
Water resistance	400 mbar		400 mbar		400 mbar		
Functional temperature	-20/+63 °C		-20/+63 °C		-20/+63 °C		
Length	132 mm		150 mm		210 mm		
Width at an interpupillary distance of 65 mm	118 mm		120 mm		145 mm		
Weight	630 g	630 g	795 g	795 g	1,265 g	1,275 g	1,295 g
Order number	52 32 11	52 32 12	52 42 11	52 42 12	52 56 31	52 56 32	52 56 33

Subject to changes in design and scope of delivery as a result of ongoing technical development.

Terra binoculars Model	ED					
	8×25	10×25	8×32	10×32	8×42	10×42
Magnification	8×	10×	8×	10×	8×	10×
Effective lens diameter	25 mm		32 mm		42 mm	
Exit pupil diameter	3.1 mm	2.5 mm	4.0 mm	3.2 mm	5.3 mm	4.2 mm
Twilight factor	14.1	15.8	16.0	17.9	18.3	20.5
Field of view at 1,000 m	119 m	97 m	135 m	112 m	125 m	110 m
Subjective angle of view	52°	54°	61°	61°	56°	60°
Close-up setting limit	1.9 m		1.6 m		1.6 m	
Diopter adjustment range	+/-3 dpt		+/-3 dpt		+/-3 dpt	
Exit pupil distance	16 mm		16.5 mm		18 mm	14 mm
Pupil distance	35–72 mm		56–74 mm		58–75.5 mm	
Lens type	ED		ED		ED	
Prism system	Schmidt-Pechan		Schmidt-Pechan		Schmidt-Pechan	
Coating	Hydrophobic ZEISS mC		Hydrophobic ZEISS mC		Hydrophobic ZEISS mC	
Nitrogen filled	yes		yes		yes	
Water resistance	100 mbar		100 mbar		100 mbar	
Operating temperature	-20/+63 °C		-15/+60 °C		-15/+60 °C	
Length	111 mm		125 mm		142 mm	
Width with an eye spacing of 65 mm	115 mm		117 mm		120 mm	
Weight	310 g		510 g		725 g	
Order number	black/green		52 32 03-99 08	52 32 04-99 08	52 42 03-99 08	52 42 04-99 08
	black/black		52 32 03-99 01	52 32 04-99 01	52 42 03-99 01	52 42 04-99 01
	grey/grey		52 25 02-99 07	52 25 03-99 07	52 32 03-99 07	52 32 04-99 07

Subject to changes in design and scope of delivery as a result of ongoing technical development.

QUALITY DEMANDED AROUND THE GLOBE: ZEISS SPOTTING SCOPES

Victory Spotting Scope	Harpia	
Model	85	95
Focal length of lens	162 mm – 486 mm	174 mm – 523 mm
Filter thread objective lens side	M86 × 1	M95 × 1
Lens diameter	85 mm	95 mm
Close focus	3.5 m	4.5 m
Height × width × length	121 × 103 × 384 mm	124 × 109 × 408 mm
Weight without eyepiece	1,934 g	2,078 g
Waterproof	400 mbar	
Nitrogen filling	yes	
Order number	52 80 47	52 80 57

	Eyepiece	
Magnification	22 – 65 ×	23 – 70 ×
Focal length	7.48 mm	
Field of view m / 1,000 m	63.2 – 21.0 m	58.8 – 19.5 m
Zoom factor	3 ×	
Exit pupil	2.50 – 1.31 mm	2.50 – 1.34 mm
Diameter	Ø 53 mm	
Length	71 mm	
Weight	220 g	
Order number	52 80 70	

Including eyepiece and lens cover. All with ZEISS T*-multi-layer-coating.

	Dialyt Spotting Scope
Model	18–45 × 65
Magnification	18 – 45 ×
Lens diameter	65 mm
Exit pupil diameter	3.6 – 1.4 mm
Field of view at 1,000 m	40 – 23 m
Close focus	10 m
Lens type	Achromat
Nitrogen filling	yes
Water resistance	400 mbar
Length × height × width	395 × 78 × 76 mm
Weight	ca. 1,195 g
Order number	52 80 07

Including eyepiece and lens cover, carrying strap.

Subject to changes in design and scope of delivery as a result of ongoing technical development.

NUMEROUS OPTIONS: ZEISS ACCESSORIES

	Tripods	Long balance plate
Model	Professional	
Material	Carbon	
Length closed	ca. 700 mm	for model Professional only
Length open	ca. 1,820 mm	
Weight	ca. 2,460 g	
Order number	21 69-972	21 69-974

Model	Astro adapter
for standard astro eyepieces	52 83 85
for 1¼" astronomy telescopes	52 83 86
Astro adapter for DiaScope	52 83 82

Model	Gavia 85
Magnification	30 – 60 ×
Lens diameter	85 mm
Exit pupil diameter	2.8 mm – 1.4 mm
Focal length	494 mm
Field of view at 1,000 m	33 m – 23 m
Close focus	3.3 m
Lens type	HD
LotuTec® / Nitrogen filling	yes / yes
Water resistance	400 mbar
Lens thread	M 86 × 1
Length	396 mm
Weight (incl. eyepiece)	ca. 1,700 g
Order number (incl. eyepiece 30 – 60 × 85)	52 80 48-0000-000

Including eyepiece and lens cover.

Adapter	Order number
Astro adapter	52 83 45
Photo lens adapter m49	52 83 48-9901
Photo lens adapter m52	52 83 48-9902
Photo lens adapter m58	52 83 48-9903

Model	Carrying case for
DiaScope 65 FL straight view	1778-946
DiaScope 65 FL angled view	1778-968
DiaScope 85 FL straight view	1778-973
DiaScope 85 FL angled view	1778-974
Conquest Gavia 85	2169-979
Victory Harpia 85	2169-977
Victory Harpia 95	2169-976

Subject to changes in design and scope of delivery as a result of ongoing technical development.

TECHNICAL SPECIFICATIONS

WITH PRECISION IN MIND: ZEISS ACCESSORIES

Bullet drop compensators BDC (ASV) Order no.

BDC (ASV) LongRange (LR) for Victory V8
1.8–14×50, 2.8–20×56
for elevation with new orders -040

for elevation and windage with new orders -050

BDC (ASV) Competition for Victory V8
4.8–35×60 for lateral with new orders -050

BDC+ (ASV+) for Victory HT
for elevation with new orders -010

for elevation and windage with new orders -020

BDC (ASV) V6 for Conquest V6
for elevation with new orders -060

Throw lever Order no.

for Conquest V4 2248-168

for Conquest V6 2224-899

Flip cover for Victory V8 /Victory HT Order no.

Ø 30 mm 2152-898

Ø 50 mm 2105-737

Ø 56 mm 2105-798

Ø 60 mm 2173-926

Neoprene cover Order no.

Size S 2231-631

Size M 2231-632

Size L 2231-633

Size XL 2231-634

Size guide with model compatibility at
www.zeiss.com/sports-optics/sizeguide

Rubber light shield (not for V8) 52 83 75

Battery cover

for spare battery (battery container) 52 16 24-8009



New!



Protective cap for riflescopes

please state the exact model

Elevation cap

please state the exact model

TECHNICAL SPECIFICATIONS

IMPROVED PERFORMANCE: ZEISS ACCESSORIES

Tripod adapter Order no.

Binofix universal tripod mount
for all binocular models 52 83 87

Tripod adaptor 1/4" for Conquest HD
(included in HD 15×56 delivery) 52 83 88

Magnification attachment Mono 3×12 Order no.

Including carrying strap and leather pouch;
triples normal binocular magnification 52 20 12

Adaptor for magnification attachment Order no.

for Victory FL/RF/HT (not for SF)
and Conquest HD 32 and 42 52 83 77

for Conquest HD 56 52 83 79

for Dialyt 8×56 GA 52 83 83

Accessories for Victory NV 5.6×62 Order no.

SLR camera adapter 52 30 06-9007

1"-flashlight mount 52 30 06-9006

Min Maglite adapter 52 30 06-9008

Pouches Order no.

for Victory SF 2060-069

for Terra Pocket 2197-806

Leather pouch for 20×60 S 52 90 83

Cordura bags Order no.

for Victory HT 42 1980-766

for Victory HT 54 2074-447

for Conquest HD 32 and Terra ED 32 52 90 35

for Conquest HD 42 and Terra ED 42 1976-008

for Conquest HD 56 1379-711

Carrying straps Order no.

Air Cell comfort straps 52 91 13

Binocular comfort straps 52 91 15



Binofix universal tripod mount



Tripod adaptor 1/4"



Magnification attachment Mono 3×12



Adaptor for magnification attachment



SLR camera adaptor



Pouch for Victory SF



Cordura bag



Pouch for Terra Pocket



Air Cell comfort straps



Binocular comfort straps

Victory Model	Monos					
	3 × 12	4 × 12	6 × 18	8 × 20	10 × 25	MiniQuick® 5 × 10
Magnification	3 ×	4 ×	6 ×	8 ×	10 ×	5 ×
Lens diameter	12 mm		18 mm	20 mm	25 mm	10 mm
Exit pupil diameter	4 mm	3 mm		2.5 mm		2 mm
Twilight factor	6	6.9	10.4	12.6	15.8	7
Field of view at 1,000 m	220 m	180 m	120 m	110 m	88 m	100 m
Subjective viewing angle	38°	41°		51°		29°
Close focus	0.2 m	0.25 m	0.3 m	3 m	4.5 m	4 m
Diopter adjustment range	+/-4 dpt					
Eye relief	12 mm	15 mm				16.5 mm
Lens type	Achromat					
Prism system	Schmidt-Pechan					-
Water resistance	splash proof					
Functional temperature range	-20/+40 °C					
Height × width	58 mm	70 mm	94 mm	101 mm	119 mm	113 mm
Weight	54 g	45 g	58 g	67 g	77 g	23 g
Order number	52 20 12	52 20 50	52 20 51	52 20 52	52 20 53	52 20 10

All with ZEISS T*-multi-layer coating.
Subject to changes in design and scope of delivery as a result of ongoing technical development.

Model	Binoculars with image stabilisation
	20 × 60 S
Magnification	20 ×
Lens diameter	60 mm
Exit pupil diameter	3 mm
Twilight factor	34.6
Field of view at 1,000 m	52 m
Subjective viewing angle	60° Ww
Close focus	14 m
Diopter adjustment range	+/-7 dpt
Eye relief	13 mm
Pupil distance	57-73 mm
Lens type	Achromat
Prism system	Porro
Water resistance	splash proof
Functional temperature range	-20/+40°C
Height × width	275 × 161 mm
Weight	1,660 g
Order number	52 60 00

Delivery including neoprene carrying strap, eyepiece cover, aluminium case.
Subject to changes in design and scope of delivery as a result of ongoing technical development.

Model	Night Vision
	5.6 × 62 NV
Magnification	5.6 ×
Lens diameter	62 mm
Field of view at 1,000 m	142 m
Close focus	5 m
Diopter adjustment range	+/-4 dpt
Eye relief	20 mm
LotuTec®	yes
Nitrogen filling	yes
Length × height × width	233 × 100 × 80 mm
Weight	ca. 1,000 g
Reticle: distance between lines	0.5 m / 100 m
Measuring range	500 m
Order number	52 30 07-9901

Delivery including cordura pouch, carrying strap, eyepiece and lens covers and 2x AA batteries.
Subject to changes in design and scope of delivery as a result of ongoing technical development.



Join the **ZEISS Hunting community**.

Follow us online:



facebook.com/ZEISSHunting



zeiss.com/hunting-blog



youtube.com/user/zeissportsoptics



[#passionforhunting](https://twitter.com/#passionforhunting)

New!



[ZEISShunting_EU](https://www.instagram.com/ZEISShunting_EU)

Customer service

Carl Zeiss Sports Optics GmbH – customer service

Gloelstrasse 3–5, 35576 Wetzlar

Germany

Phone +49 (0)6441 404 500 | Fax +49 (0)6441 483 69

service.sportsoptics@zeiss.com

Carl Zeiss AG

Consumer Products division

Carl-Zeiss-Strasse 22

73447 Oberkochen

Germany

www.zeiss.com/sports-optics

