

NIGHTFORCE®

2019 PRODUCT CATALOG



WELCOME

WE'VE BEEN EXPECTING YOU.

If you're like us, you learned to shoot with an inexpensive scope and perhaps a hand-me-down rifle. As your proficiency grew, you soon realized the limitations of average riflescopes, and came to the conclusion that you can replace several marginal riflescopes over a lifetime. Or just buy one really good one.

Most of our customers are experienced hunters or shooters who have grown tired of limitations. They understand that the only true bargain is a riflescope that will last a lifetime—or more—and performs impeccably under the worst conditions possible, with predictable results every time they pull the trigger.

Rare is the shooter who doesn't seek greater accuracy, more distance, and tighter groups. Many put vast sums of money into their rifle, devote countless hours to finding the perfect load, yet give little thought to their optics.

That is unfortunate.

The finest, most expensive custom rifle will only shoot as well as its optics allow. . . while even a modest production rifle is capable of outstanding accuracy when paired with a world-class riflescope.

But, if you're considering a Nightforce, you already know these things.

NIGHTFORCE



A great many of the men and women who build Nightforce optics are serious hunters, competitive and recreational shooters. Several joined the company after a military career that first introduced them to Nightforce riflescopes. This brings a passion and commitment to their craft rarely found in any business. For them, building a Nightforce is a labor of love, and extension of who they are and what they believe in.

You can be assured that every Nightforce is built and tested to the highest possible standards:

Ours.



ATACR™ 5-25x56 F1 on an Accuracy International AX in the mountains of Idaho.

INSIDE:

Why Nightforce?	2	NXS™ 2.5-10 x 42 Compact	28	Reticles	54
Contents	3	NXS™ 3.5-15 x 50	30	X-Treme Duty™ rings & bases	58
Building a Nightforce	4	NXS™ 5.5-22 x 50/56	32	Ringtop accessories	60
The ATACR™ family of riflescopes	8	NXS™ 8-32 x 56	34	Nightforce Tool Kit and Cleaning Kit	61
ATACR™ 1-8 x 24 F1	10	The SHV™ family of riflescopes	36	Standard Duty rings & bases	62
ATACR™ 4-16 x 42 F1	12	SHV™ 3-10 x 42	38	Additional accessories	63
ATACR™ 4-16 x 50 F1/F2	14	SHV™ 4-14 x 50 F1	40	TS-82™ & TS-80™ spotting scopes	64
ATACR™ 5-25 x 56 F2	16	SHV™ 4-14 x 56	42	Spotting scope accessories	66
ATACR™ 5-25 x 56 F1	18	SHV™ 5-20 x 56	44	Nightforce tripod	67
ATACR™ 7-35 x 56 F1/F2	20	Competition™ & Precision Benchrest riflescopes	46	MIL-SPEC riflescopes	68
B.E.A.S.T.™ 5-25 x 56 F1	22	Competition™ 15-55 x 52	48	Warranty & customer service	70
NX8™ 1-8 x 24 F1	24	Competition™ SR Fixed 4.5 x 24	50	Contact us	71
The NXS™ family of riflescopes	26	Precision Benchrest 8-32 x 56 & 12-42 x 56	52		

BUILDING A NIGHTFORCE

IF IT WERE EASY, EVERYONE WOULD DO IT.

Consider the challenges of making a Nightforce riflescope. Optically, you are creating an instrument of extreme precision, built to tolerances often finer than a human hair. It requires many of the same techniques used in the very best laboratory microscopes and in massive, delicately balanced scientific telescopes that peer deep into the heavens.

Then you're tasked with putting these perfectly matched optics into the most compact package possible, eliminating every ounce of excess weight, and making them impervious to extreme weather conditions as well as to constant pounding from the most powerful rifle calibers over thousands of rounds.

It is a huge technological challenge. Frankly, there are very few riflescope companies up to it.

Fortunately, we are.

There is no such thing as "mass production" at Nightforce. Only a skilled human eye and human hand are sensitive enough to perform many of the critical operations involved in assembling a precision optical instrument.



Before they leave the factory, Nightforce riflescopes are subjected to conditions far beyond most anything you will ever encounter in the field. During our impact tests, riflescopes must endure repeated impacts of over 1200 Gs of force on multiple axes.

After each severe impact, the riflescope is hand-checked on a collimator for tracking accuracy and overall integrity. If we can't make it fail, chances are you can't either.



Reticles are manufactured to microscopic tolerances. We do not believe in "generic" reticles. Our reticles have been specifically designed and tailored to complement the riflescopes in which they are offered.

Nightforce headquarters are located in the forests of Idaho, a hunting, fishing and shooting paradise. It makes field testing very convenient.



WHAT WE DO IN HERE...

TURRET TRACKING AND CONSISTENCY

If a scope manufacturer even bothers to check for turret accuracy—and many don't—they often allow a “tolerable” error or don't verify accuracy over the entire adjustment range.

At Nightforce, “good enough” is not good enough. During the manufacturing process we inspect our scopes to ensure perfect clicks and absolute precision across the entire range of adjustment.

This means that when you make a shot at any distance, regardless of how much windage or elevation adjustment you've made, you can trust your turrets—and your Nightforce—to deliver your shot predictably and on target.

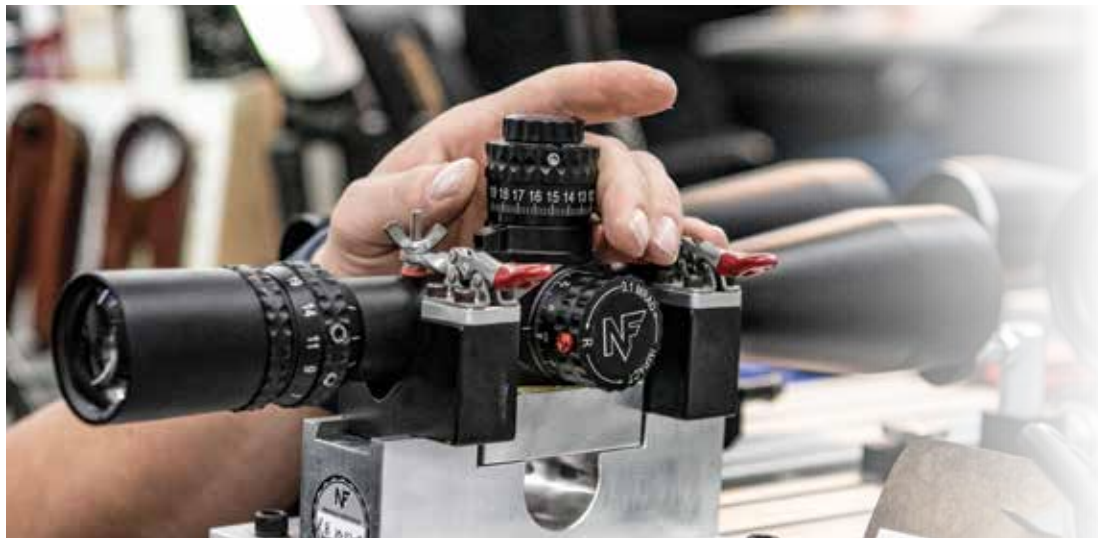

MEANS YOU CAN COUNT ON US OUT THERE.

A WARRANTY WON'T HELP YOU ON THE SIDE OF A MOUNTAIN.

What is your time worth?

If you're on a hunt halfway around the world, on the firing line at a once-a-year competition, or trying to complete a critical mission, your time is priceless. You might only get one shot at it. Literally. At that moment, the most generous warranty on earth won't help you if your scope fails.

That's why we put so much time and attention into little things. Because little things overlooked have a way of becoming big problems.

Many optics companies brag that their products are “backed by such-and-such warranty.” We see it differently. Our warranty is backed by products that have almost no chance of ever letting you down. The best warranty is one you'll never need.



Nightforce performance, quality control and reliability under extreme conditions played a major role in the decision by the U.S. Marine Corps to equip their Mk13 Mod7 sniper rifles with our MIL-SPEC ATACR™ 5-25x56 F1 riflescopes.





ATACR™
ADVANCED TACTICAL RIFLESCOPE

All ATACR™ riflescopes are rated for use with .50 BMG rifles.



THE ATACR™ FAMILY OF RIFLESCOPES: SERVING THE FRONT LINE. AND THE BLUE LINE.

If there is such a thing as a “professional” riflescope, it is an ATACR™. They are designed for military, law enforcement, and other tactical professionals. . . and for those who simply want to shoot like a professional.

An ATACR™ riflescope is the combination of the finest materials, engineering expertise, mechanical reliability and optical performance available today. Simply put, there is no expense spared, no detail overlooked in building a Nightforce ATACR™.

They are the basis for our Mil-Spec riflescopes, currently in use by several branches of the U.S. Military and allies around the world.

All ATACR™ riflescopes feature ED glass, which produces brilliant images, superb color contrast, and exceptional resolving power—allowing you to distinguish the smallest targets at extreme distances.

Our higher-power ATACR™ riflescopes, designed for extreme long-range precision, meet or exceed the capacity of any known rifle cartridge. Our lower-magnification models provide unmatched versatility in a vast range of shooting environments.

They are an investment in a lifetime of accuracy and reliability.



ATACR™ 1-8 x 24 F1



ATACR™ 4-16 x 42 F1



ATACR™ 4-16 x 50 F1/F2



ATACR™ 5-25 x 56 F2



ATACR™ 5-25 x 56 F1



ATACR™ 7-35 x 56 F1/F2

What is ED glass?

“ED” stands for “extra-low dispersion.” The glass elements in an ordinary lens can provide distortion of the image wavelengths resulting in a compromise of the image. ED glass focuses these wavelengths to a much more precise point, producing brighter color, higher resolution and better image contrast. In layman’s terms, it is comparable to going to an HDTV from a standard definition TV.



1-8x24 F1

NOTHING IS TOO CLOSE FOR COMFORT.

There are times when the wide field of view offered by open sights can literally be a lifesaver. But, open sights are far from ideal when you must place a precise shot at an extended distance. The ATACR™ 1-8x24 F1 addresses both concerns.

The daylight-visible center red dot allows for rapid engagements. Unlike a red dot sight, our 1-8x also allows you to locate, identify and engage targets at substantial ranges. The intelligent FC-DM first focal plane reticle also provides precise hold over and wind hold points.

Just over 10 inches in length and only 21 ounces, with low-profile Mil-Radian adjustments, it is barely noticeable on any rifle platform. Until you need it, that is.



Magnification range	1-8x
Focal plane	First
Body tube diameter	34 mm
Overall length	10.06"/256 mm
Mounting length	5.67"/144 mm
Weight	21 oz/595 g
Click value	.1 MRAD
Internal adjustment range	E: 30 MRAD W: 30 MRAD
Parallax adjustment	Fixed @ 125 m
Eye relief	3.74"/95 mm
Field of view @ 100 yd/m	1x: 96.1 ft/29.3 m 8x: 13.1 ft/4.0 m
Exit pupil	1x: 11.26 mm 8x: 3.19 mm
Illumination	Daylight visible, externally adjustable, two night vision settings
Elevation feature	Capped, finger-adjustable
Power Throw Lever	Standard
Reticles available	FC-DM™



The ATACR™ 1-8x24 F1 was created to offer a major capability enhancement to shooters from CQB to extended ranges. In 2018, US SOCOM selected a variant as their new FFP Squad Variable Power Scope (S-VPS).



4-16x42 F1

FLYING FAST AND LOW.

Our ATACR™ 4-16x42 F1 was created to maximize the potential of precision semi-automatic rifles—a need identified by U.S. military and civilian shooters. It is designed for rapid target engagement, with a low profile and an overall length of just 12.6 inches.

Like all Nightforce ATACR™ riflescopes, its ED glass produces images of striking brilliance and clarity. ZeroHold™ technology provides an instant return to your chosen zero, and also allows dialing below zero. A wide range of intelligent first focal plane reticles, in MOA or MRAD configurations, address virtually any shooting environment.



ZeroHold
Digillum

Magnification range	4-16x
Focal plane	First
Body tube diameter	34 mm
Overall length	12.6"/320 mm
Mounting length	6.3"/160 mm
Weight	30 oz/850 g
Click value	.250 MOA or .1 MRAD
Internal adjustment range	E: 89 MOA/26 MRAD W: 60 MOA/18 MRAD
Parallax adjustment	45 yd—∞
Eye relief	3.54"/90 mm
Field of view @ 100 yd/m	4x: 26.9 ft/8.1 m 16x: 6.9 ft/2.1 m
Exit pupil	4x: 10.3 mm 16x: 2.7 mm
Illumination	Digillum™
Elevation feature	ZeroHold®
Power Throw Lever	Standard
Reticles available	MOAR™ MIL-C™ MIL-R™ MIL-XT™ H-59™ TReMoR 3™

Showing its potential on precision semi-auto rifles, this ATACR™ 4-16x42 F1 is paired with an Extended Unimount™ atop a FN SCAR 20S rifle.





4-16x50 F1/F2

TACTICAL? HUNTING? YES.

Shooters who choose the ATACR™ 4-16x50 will enjoy superb low-light performance, ED glass and extensive elevation adjustment, housed in a riflescope impervious to recoil from the largest calibers. Its resolution and clarity allows you to count the points on a distant trophy buck in the field, or distinguish friend from foe in a more serious environment.

Hunters might opt for the second focal plane reticle version, while tactical shooters might prefer the distinctive advantages of first focal plane placement, with proprietary reticles carefully matched to each. Either way, they're in for an eye-opening experience.

	4-16x50 F1	4-16x50 F2
Magnification range	4-16x	4-16x
Focal plane	First	Second
Body tube diameter	34 mm	34 mm
Overall length	13.1"/333 mm	13.1"/333 mm
Mounting length	6.32"/161 mm	6.32"/161 mm
Weight	33.3 oz/944 g	33.3 oz/944 g
Click value	.250 MOA or .1 MRAD	.250 MOA or .1 MRAD
Internal adjustment range	E: 110 MOA/30 MRAD	E: 110 MOA/30 MRAD
	W: 60 MOA/16.4 MRAD	W: 60 MOA/16.4 MRAD
Parallax adjustment	45 y-∞	45 y-∞
Eye relief	3.5"/89 mm	3.5"/89 mm
Field of view @ 100 yd/m	4x: 26.9 ft/8.2 m	4x: 26.9 ft/8.2 m
	16x: 6.9 ft/2.1 m	16x: 6.9 ft/2.1 m
Exit pupil	4x: 9.5 mm	4x: 9.5 mm
	16x: 3.17 mm	16x: 3.17 mm
Illumination	Digillum™	Digillum™
Elevation feature	ZeroStop®	ZeroStop®
Power Throw Lever	Standard	Standard
Reticles available	MOAR™	MOAR™
	MIL-C™	MIL-R™
	MIL-X™	



ZeroStop
NIGHTFORCE
Digillum



An ATACR™ 4-16x50 F1 mounted on a JP Rifles LRP-07 in a Nightforce 34mm Unimount™.

ATACR™ 5-25x56 F2

ADVANCED TACTICAL RIFLESCOPE

IS YOUR RIFLE UP TO IT?

Designed and built for superb long-range performance, the ATACR™ 5-25x56 will exceed the potential of the flattest-shooting cartridges and high ballistic coefficient projectiles. Quite simply, this riflescope has more long-range capability than your rifle.

A full 120 MOA/35 Mil-Radian of elevation adjustment will put just about any target in reach. Like all ATACR™ riflescopes, its ED glass provides brilliant images and extraordinary resolving power at all distances.

It puts the “long” in “long range.”

Magnification range	5-25x
Focal plane	Second
Body tube diameter	34 mm
Overall length	14.3"/363 mm
Mounting length	6.13"/156 mm
Weight	39 oz/1108 g
Click value	.250 MOA or .1 MRAD
Internal adjustment range	E: 120 MOA/35 MRAD W: 60 MOA/17 MRAD
Parallax adjustment	45 yd-∞
Eye relief	3.54"/90 mm
Field of view @ 100 yd/m	5x: 17.96 ft/5.47 m 25x: 4.92 ft/1.5 m
Exit pupil	5x: 10.52 mm 25x: 2.28 mm
Illumination	Digillum™
Elevation feature	ZeroStop®
Power Throw Lever	Standard
Reticles available	MOAR™ MOAR-T™ MIL-R™



ZeroStop
NIGHTFORCE
Digillum



Samantha Smithko of Cutting Edge Bullets prepares to fire at the 2018 King of 2 Mile competition in Raton, NM.

ATACR™ 5-25x56 F1

SEE WHAT YOU'VE BEEN MISSING.

Chances are, you'll never forget your first look through the ED glass of our ATACR™ 5-25x56 F1. We can assure you that you've never seen an image through a riflescope as bright and impressive.

First focal plane technology means consistent reticle values, regardless of the magnification setting. The ATACR 5-25x56 F1 is offered with a wide range of options, including intelligent reticles.

Extensive elevation travel allows target engagements at distances previously considered "out of range," if you're willing to practice and if your rifle is up to it. Your riflescope certainly will be.

Magnification range	5-25x
Focal plane	First
Body tube diameter	34 mm
Overall length	15.37"/390 mm
Mounting length	5.9"/150 mm
Weight	37.6 oz/1066 g
Click value	.250 MOA or .1 MRAD
Internal adjustment range	E: 120 MOA/35 MRAD
	W: 80 MOA/24 MRAD
Parallax adjustment	45 yd-∞
Eye relief	3.54"/90 mm
Field of view @ 100 yd/m	5x: 18.7 ft/5.7 m
	25x: 4.9 ft/1.5 m
Exit pupil	5x: 8.3 mm
	25x: 2.3 mm
Illumination	DigIllum™
Elevation feature	ZeroStop®
Power Throw Lever	Standard
Reticles available	MOAR™
	MIL-C™
	MIL-R
	MIL-XT™
	H-59™
	TReMoR 3™



The ATACR™ 5-25x56 F1 has been selected by the United States Marine Corps, and other military services and government agencies around the world for long-range rifle systems. This one is mounted to a Proof Research Tac III rifle, capable of making hits at well over one mile away.

ATACR™ 7-35x56 F1/F2

ADVANCED TACTICAL RIFESCOPE

IT DOESN'T JUST PUSH THE ENVELOPE. IT REDEFINES THE ENVELOPE.

Building a high-magnification riflescope that delivers razor-sharp imaging across the entire zoom range is not easy. Fortunately, it is a technological challenge we've mastered in our ATACR™ 7-35x56 riflescopes.

The brilliance and clarity that only the finest ED glass can provide is matched with the virtually indestructible construction that characterizes all of our ATACR™ riflescopes, resulting in what is, quite simply, the most precise, powerful instrument for extended-range shooting money can buy.

Push the envelope? The ATACR™ 7-35x56 redefines it.

ZeroStop[®]
NIGHTFORCE
Digillum™



	7-35x56 F1	7-35x56 F2
Magnification range	7-35x	7-35x
Focal plane	First	Second
Body tube diameter	34 mm	34 mm
Overall length	16"/406 mm	16"/406 mm
Mounting length	6.5"/167 mm	6.5"/167 mm
Weight	39.3 oz/1113 g	39.3 oz/1113 g
Click value	.250 MOA or .1 MRAD	.250 MOA or .1 MRAD
Internal adjustment range	E: 100 MOA/29 MRAD W: 60 MOA/17 MRAD	E: 100 MOA/29 MRAD W: 60 MOA/17 MRAD
Parallax adjustment	11 yd—∞	11 yd—∞
Eye relief	3.5"/91 mm	3.5"/89 mm
Field of view @ 100 yd/m	7x: 14.97 ft/4.96 m 35x: 3.44 ft/1.05 m	7x: 14.97 ft/4.96 m 35x: 3.44 ft/1.05 m
Exit pupil	7x: 6.0 mm 35x: 1.6 mm	7x: 6.0 mm 35x: 1.6 mm
Illumination	Digillum™	Digillum™
Elevation feature	ZeroStop®	ZeroStop®
Power Throw Lever	Standard	Standard
Reticles available	MOAR™ MIL-C™ MIL-R™ MIL-X™ H-59™ TRMoR 3™	MOAR-T™ MIL-C™



Nightforce North American Sales Manager Alan Stilwell is shown using his ATACR™ 7-35x56 F1 to engage targets well past one mile with a Barrett M99 in .416 Barrett.

B.E.A.S.T.™ 5-25x56 F1

BEST EXAMPLE OF ADVANCED SCOPE TECHNOLOGY

IF YOU NEED ONE, YOU'LL KNOW.

It was a beast to engineer. It was a beast to build. Which earned it the name which stands for "Best Example of Advanced Scope Technology." It lives up to that name, with capabilities far beyond any ordinary optic.

Its unique i4F™ elevation controls include a 360° brake, preventing unintended adjustments. With a single throw, the M2™ Precision Elevation Lever provides additional fine elevation adjustments of .250 MOA or .1 Mil-Radian for enhanced precision at extreme ranges. XtremeSpeed™ adjustments allow 120 MOA/35 Mil-Radian of elevation travel, half of that covered in a single rotation. And ZeroStop® technology ensures you will never have to hunt for your original zero setting.

It's not a riflescope everyone needs. But if you do need one, chances are you already know.



ZeroStop
NIGHTFORCE
Digillum

Magnification range	5-25x
Focal plane	First
Body tube diameter	34 mm
Overall length	15.37"/390 mm
Mounting length	5.9"/150 mm
Weight	40 oz/1134 g
Click value	.5 MOA/.25 MOA .2 MRAD/.1 MRAD
Internal adjustment range	E: 120 MOA/35 MRAD W: 80 MOA/23 MRAD
Parallax adjustment	45 yd-∞
Eye relief	3.54"/90 mm
Field of view @ 100 yd/m	5x: 18.7 ft/5.9 m 25x: 4.92 ft/1.45 m
Exit pupil	5x: 8.3 mm 25x: 2.3 mm
Illumination	Digillum™
Elevation feature	ZeroStop®
Power Throw Lever	Standard
Reticles available	MOAR™ MIL-C™ MIL-R™ H-59™ TReMoR 3™

The B.E.A.S.T.™ 5-25x56 F1 is currently used in competitive rifle matches, by big game hunters and on the front lines by militaries around the world.



NX8™ 1-8x24 F1

“VERSATILITY” IS ITS MIDDLE NAME.

The first of our new NX8™ series, the 1-8x24 F1 puts the remarkable power of a full 8x zoom range into a compact, lightweight, purpose-designed riflescope optimized for short- to medium-range shooting.

A mere 8.75" in length and 17 ounces, it sits low and comfortably on any rifle platform. Its daylight visible center red dot allows the shooter to engage targets with the speed of a red dot sight, but as target range increases, its first focal plane reticles provide precise hold points.

In close quarters, the NX8™ 1-8x24 provides the wide field of view of open sights, yet a quick turn to 8x allows precise shot placement at substantial distances. That's the power of eight. And of the 1-8x24 F1.



Magnification range	1-8x
Focal plane	First
Body tube diameter	30 mm
Overall length	8.75"/222 mm
Mounting length	5.7"/144 mm
Weight	17 oz/482 g
Click value	.5 MOA or .2 MRAD
Internal adjustment range	E: 100 MOA/30 MRAD W: 100 MOA/30 MRAD
Parallax adjustment	Fixed at 125 m
Eye relief	3.75"/95.3 mm
Field of view @ 100 yd/m	1x: 106 ft/32.3 m 8x: 13.2 ft/4.0 m
Exit pupil	1x: 7.9 mm 8x: 3.0 mm
Illumination	Daylight visible, externally adjustable
Elevation feature	ZeroStop®
Power Throw Lever	Standard
Reticles available	FC-MOA™ FC-MIL™



The NX8™ 1-8x24 F1 is a perfect companion to nearly any carbine on the market.



THE NXS™ FAMILY OF RIFLESCOPES: HOW LEGENDS ARE MADE.

For over 20 years, Nightforce NXS™ riflescopes have performed impeccably in the most brutal, unforgiving environments on earth. Conceived to exceed U.S. military performance standards, they have served reliably in theaters of war around the globe.

Serious hunters rely upon them for their ability to endure repeated recoil, blistering heat, sub-zero cold, rain, sleet, snow, mountains, rocks, falls, horses and even airline baggage handlers.

NXS™ riflescopes are built to standards that exceed virtually any other riflescope on the market. Each must pass a battery of tests—including side and front impact—that would destroy an ordinary optic. Only the highest quality, most durable components are used in NXS™ riflescopes, assuring a lifetime of repeatable precision. NXS™ lenses are painstakingly bedded with our proprietary Mil-Spec formulation, reducing any glass-to-metal contact that can result in breakages, stress, misalignment, and thermal shock.

It's how legends are built.

All NXS™ riflescopes are rated for use with .50 BMG rifles.



NXS™ 2.5-10 x 42



NXS™ 3.5-15 x 50



NXS™ 5.5-22 x 50



NXS™ 5.5-22 x 56



NXS™ 8-32 x 56

NXS 2.5-10x42

COMPACT IN EVERY WAY. EXCEPT IN PERFORMANCE.

A mere 11.9 inches in length and 20.5 ounces in weight, the NXS™ 2.5-10x42 Compact is a perfect match for a lightweight mountain rifle or fast-handling big bore safari rifle, and an ideal choice for the AR-15/AR-10 platforms.

Its light transmission is outstanding, superior to that of other much larger and bulkier riflescopes. Side parallax adjustment along with Digillum™ red and green reticle illumination make it one of the most advanced, versatile riflescopes we offer.

Magnification range	2.5-10x
Focal plane	Second
Body tube diameter	30 mm
Overall length	11.9"/302 mm
Mounting length	5.1"/130 mm
Weight	20.5 oz/581 g
Click value	.250 MOA or .1 MRAD
Internal adjustment range	E: 100 MOA/29 MRAD W: 100 MOA/29 MRAD
Parallax adjustment	25 yd-∞
Eye relief	3.5"/85 mm
Field of view @ 100 yd/m	2.5x: 44 ft/13.4 m 10x: 11 ft/3.4 m
Exit pupil	2.5x: 15.5 mm 10x: 4.4 mm
Illumination	Digillum™
Elevation feature	ZeroStop®
Power Throw Lever	Standard
Reticles available	MOAR™ MIL-R™



ZeroStop
NIGHTFORCE
Digillum

Your rifle will thank you when you treat it to the lightweight but capable NXS™ 2.5-10x42. Shown here on a JP Rifles .308 carbine.



NXS 3.5-15x50

JUST ABOUT BULLETPROOF.

Originally developed for use on military small arms, it offers an extremely versatile magnification range providing outstanding mid- to long-range capability.

The NXS™ 3.5-15x50 at right was shot completely through by an enemy 7.62x39 round fired at a U.S. soldier. . . yet the unharmed serviceman used it for the next three days, completing his mission. The 3.5-15x50 adapts comfortably to a variety of rifle platforms, survives abuse that would destroy lesser riflescopes, and is impervious to heavy recoil. And, apparently, to enemy bullets.



Magnification range	3.5-15x
Focal plane	Second
Body tube diameter	30 mm
Overall length	14.7"/373 mm
Mounting length	6.1"/155 mm
Weight	30 oz/850 g
Click value	.250 MOA or .1 MRAD
Internal adjustment range	E: 110 MOA/30 MRAD W: 80 MOA/22 MRAD
Parallax adjustment	50 yd—∞
Eye relief	3.9"/99 mm
Field of view @ 100 yd/m	3.5x: 27.6 ft/8.4 m 15x: 7.3 ft/2.2 m
Exit pupil	3.5x: 14.3 mm 15x: 3.6 mm
Illumination	Analog
Elevation feature	ZeroStop®
Power Throw Lever	Accessory
Reticles available	MOAR™ MIL-R™

ZeroStop
NIGHTFORCE



Our NXS™ 3.5-15x50 is a popular choice with law enforcement agencies around the country. It works equally well on a favorite hunting or target rifle. Shown with a Barrett MRAD.

NXS 5.5-22x50/56

PROVEN IN BATTLE. AND EVERYWHERE ELSE.

The NXS™ 5.5-22x was originally developed for U.S. military extreme long range shooting and hard target interdiction. Both models provide a broad magnification range, excellent eye relief, and 100 MOA of elevation travel. Superb resolution at high magnification expands the world of extended range shooting for the accomplished marksman. They are the most proven, most popular members of the world's toughest, most reliable riflescope family.

	5.5-22x50	5.5-22x56
Magnification range	5.5-22x	5.5-22x
Focal plane	Second	Second
Body tube diameter	30 mm	30 mm
Overall length	15.1"/384 mm	15.2"/385 mm
Mounting length	6.6"/168 mm	6.6"/168 mm
Weight	31 oz/879 g	32 oz/907 g
Click value	.250 MOA or .1 MRAD	.250 MOA or .1 MRAD
Internal adjustment range	E: 100 MOA/29 MRAD	E: 100 MOA/29 MRAD
	W: 60 MOA/16 MRAD	W: 60 MOA/16 MRAD
Parallax adjustment	50 y-∞	50 y-∞
Eye relief	3.7"/95 mm	3.9"/99 mm
Field of view @ 100 yd/m	5.5x: 17.5 ft/5.3 m	5.5x: 17.5 ft/5.3 m
	22x: 4.7 ft/1.4 m	22x: 4.7 ft/1.4 m
Exit pupil	5.5x: 9.1 mm	5.5x: 10.2 mm
	22x: 2.3 mm	22x: 2.5 mm
Illumination	Analog	Analog
Elevation feature	ZeroStop®	ZeroStop®
Power Throw Lever	Accessory	Accessory
Reticles available	MOAR™	MOAR™
	MOAR-T™	MOAR-T™
	MIL-R™	MIL-R™



While developed for military use, the NXS™ 5.5-22x will provide a lifetime of service on any rifle you choose.

NXS 8-32x56

TAMES EXTREME RANGES AND EXTREME CONDITIONS.

Take the pinpoint precision of a fine long-range target scope, surround it with the ultra-reliable, supremely rugged build that characterizes every NXS™ riflescope, and you have our NXS™ 8-32x56. Unlike many high-power variable scopes that suffer at the high and low ends, the 8-32x56 excels at every magnification setting.

It has been the choice of dozens of winners of the most demanding, prestigious competitions in the world, including several Wimbledon Cups. It is absolutely precise and repeatable over a lifetime of hard use, providing the shooter with complete confidence at extreme ranges in the most demanding conditions.

Magnification range	8-32x
Focal plane	Second
Body tube diameter	30 mm
Overall length	15.9"/404 mm
Mounting length	6.7"/170 mm
Weight	34 oz/964 g
Click value	.250 MOA or .1 MRAD
Internal adjustment range	E: 65 MOA/18 MRAD W: 45 MOA/12 MRAD
Parallax adjustment	50 yd—∞
Eye relief	3.8"/98 mm
Field of view @ 100 yd/m	8x: 12.1 ft/3.7 m 32x: 3.1 ft/1.0 m
Exit pupil	8x: 7.0 mm 32x: 1.8 mm
Illumination	Analog
Elevation feature	ZeroStop®
Power Throw Lever	Accessory
Reticles available	MOAR™ MOAR-T™ MIL-R™ NP-2DD™



Reach out and touch distant targets with a combination like the NXS™ 8-32x56 and an FN Ballista in .338 Lapua.



Tough sheep hunting terrain is no match for a tough riflescope—in this case, an SHV™ 4-14x50 F1—or a tough hunter like Kristy Titus.



THE SHV™ FAMILY OF RIFLESCOPES: PERFORMANCE FAR BEYOND THE PRICE.

Several well-known manufacturers have brought “affordable” riflescopes to the market in recent years, hoping to attract buyers to an inferior product with a high-end name attached. Many shooters have been less than thrilled with such purchases.

That’s because there are only two ways to lower the cost of a riflescope. One is to reduce the quality of its glass, its components, and its construction.

The second way is to build it with fewer options, yet without sacrificing quality. That is the road we took with the SHV™.

SHV™ riflescopes are designed for maximum versatility across a wide range of shooting disciplines; whether you enjoy target shooting, pursuing big game, varmint shooting, or all of the above.

Shooters on a budget can now enjoy Nightforce quality at a reasonable cost. In fact, you will find that SHV™ riflescopes outperform many brands that cost much more.

That shouldn’t come as a surprise. After all, they say “Nightforce” on the side.

All SHV™ riflescopes are rated for use with .50 BMG rifles.



SHV™ 3-10x42



SHV™ 4-14x50 F1



SHV™ 4-14x56



SHV™ 5-20x56



3-10x42

A HUNTER'S BEST FRIEND.

From the sun-baked plains of Africa, to the frozen peaks of Alaska, to a bean field favored by a trophy whitetail, the SHV™ 3-10x42 will easily take on just about any game, anywhere in the world. That it happens to also be the most affordable riflescope we make is just a bonus.

Reticle illumination is now standard. Under any lighting conditions you'll enjoy bright, crisp images, excellent resolution for target identification, and a compact, lightweight design that matches beautifully with a hunting rifle... and with your budget.

Magnification range	3-10x
Focal plane	Second
Body tube diameter	30 mm
Overall length	11.6"/295 mm
Mounting length	5.1"/130 mm
Weight	22.2 oz/629 g
Click value	.250 MOA
Internal adjustment range	E: 90 MOA W: 80 MOA
Parallax adjustment	Fixed at 125 yd
Eye relief	3.46"/88 mm
Field of view @ 100 yd/m	3x: 34.9 ft/10.6 m 10x: 11 ft/3.4 m
Exit pupil	3x: 10.7 mm 10x: 4.4 mm
Illumination	Standard
Elevation feature	Capped, finger adjustable
Power Throw Lever	Accessory
Reticles available	MOAR™ Forceplex™ (N. America) 4A (Int'l only)



The SHV™ 3-10x42 saves weight while maximizing the potential of lightweight rifles, such as this Barrett Fieldcraft.



4-14x50 F1

AWARD-WINNING FIRST FOCAL PLANE PERFORMANCE.

Since their introduction, Nightforce SHV™ riflescopes have won awards (including two *Outdoor Life* Editor's Choice honors) and have won the hearts of shooters who want Nightforce quality in a simpler, more affordable package.

Those who prefer the advantages of first focal plane reticle placement have a winner in our SHV™ 4-14 x 50 F1. Exposed ZeroSet™ adjustments, in either .250 MOA or .1 Mil-Radian increments, are standard. . . as is a center-illuminated reticle.

Highly versatile, with ZeroSet™ technology that always allows you to return quickly to zero, its performance will reward you for years to come.

Magnification range	4-14x
Focal plane	First
Body tube diameter	30 mm
Overall length	14.8"/376 mm
Mounting length	6.1"/155 mm
Weight	30 oz/850 g
Click value	.250 MOA or .1 MRAD
Internal adjustment range	E: 90 MOA/27 MRAD W: 70 MOA/19 MRAD
Parallax adjustment	25 yd-∞
Eye relief	3.15"/80 mm
Field of view @ 100 yd/m	4x: 25.1 ft/7.65 m 14x: 7.4 ft/2.25 m
Exit pupil	4x: 10.8 mm 14x: 3.3 mm
Illumination	Standard
Elevation feature	ZeroSet™
Power Throw Lever	Accessory
Reticles available	MOAR™ (F1) MIL-R™ (F1)



A Nightforce SHV™ 4-14x50 F1 delivers maximum precision to any rifle, whether AR or bolt action. Shown here on top of a Daniel Defense Mk 12 rifle.

SHOOTER HUNTER ARCHER™
SHV 4-14x56

THE RIFESCOPE THAT STARTED A REVOLUTION.

This, our first SHV™, started a revolution in affordable riflescopes.

It remains one of the most versatile riflescopes we make... equally efficient in putting small groups on paper at long ranges, dispatching a prairie dog or coyote on the run, or matched with a powerful, flat-shooting rifle for big game most anywhere on earth.

It certainly isn't short on features. with side parallax control and a choice of two of our most popular reticles (illuminated or non-illuminated)... along with clarity, brightness and resolution you must see to appreciate.

The SHV™ 4-14 x 56 will outperform any riflescope in its class... and challenge many than cost much more.

Magnification range	4-14x
Focal plane	Second
Body tube diameter	30 mm
Overall length	14.8"/376 mm
Mounting length	5.79"/147 mm
Weight	26.9 oz/763 g (non-illum) 28.5 oz/808 g (illum)
Click value	.250 MOA
Internal adjustment range	E: 100 MOA W: 70 MOA
Parallax adjustment	25 yd-∞
Eye relief	3.54"/90 mm
Field of view @ 100 yd/m	4x: 24.9 ft/7.59 m 14x: 7.59 ft/2.23 m
Exit pupil	4x: 12.0 mm 14x: 3.6 mm
Illumination	Optional
Elevation feature	Capped, finger adjustable
Power Throw Lever	Accessory
Reticles available	MOAR™ Forceplex™ (N. America) 4A (Int'l only)



Engage targets or game animals with new levels of confidence and precision using a Nightforce SHV™ 4-14x56.



5-20x56

LONG-DISTANCE CALLING.

The most powerful of our SHV™ series performs beautifully at both close and extended ranges on varmints, big game, and for making tight groups on paper.

You get outstanding clarity, crispness and color contrast at every magnification setting. It features a full 80 MOA of elevation adjustment, side parallax adjustment and ZeroSet™ technology which allows a quick return to your initial zero setting, regardless of how many elevation adjustments you've made.

It's tough, reliable and big calibers won't bother it. The SHV™ 5-20x56 won't bother your finances too much, either.

Magnification range	5-20x
Focal plane	Second
Body tube diameter	30 mm
Overall length	15.2"/386 mm
Mounting length	6.5"/165 mm
Weight	29.1 oz/825 g (non-illum)
	30.5 oz/865 g (illum)
Click value	.250 MOA
Internal adjustment range	E: 80 MOA
	W: 50 MOA
Parallax adjustment	25 yd-∞
Eye relief	3.54"/90 mm
	Field of view @ 100 yd/m
Exit pupil	5x: 17.9 ft/5.46 m
	20x: 5.0 ft/1.52 m
5x: 8.7 mm	
20x: 2.5 mm	
Illumination	Optional
Elevation feature	ZeroSet™
Power Throw Lever	Accessory
Reticles available	MOAR™
	Forceplex™ (N. America)
	4A (Int'l only)



The SHV™ 5-20x56 will increase your confidence and your capability. It is shown with an HS Precision 6.5 Creedmoor.



COMPETITION™ PRECISION BENCHREST RECORD-SETTING RIFLESCOPES.

Since our founding in 1992, Nightforce riflescopes have won more matches and set more records in long-range competition than any other brand. You're looking at the reasons why.

Our Precision Benchrest series is still going strong, proven over a quarter of a century of reliability.

As long-range competitions add ever-more demanding events, we identified the need for a new class of riflescopes capable of maximum precision at extreme ranges, plus optics tailored for highly specific events. Thus was born our Competition™ family.

Competition™ riflescopes are purpose-built for the competitive shooter. They are not double-duty or modified optics with a fancy name applied.

They are carefully matched with our own unique reticles, developed over decades of experience and with input from record-setting shooters, created specifically to complement the extraordinary ability of these riflescopes.

All Competition™ and Precision Benchrest riflescopes are rated for use with .50 BMG rifles.



Competition™ SR Fixed 4.5 x 24



Competition™ 15-55 x 52



Precision Benchrest 8-32 x 56



Precision Benchrest 12-42 x 56

Nightforce is proud to be a long-time supporter of the U.S. F-Class rifle teams and other competitive teams throughout the world.



COMPETITION™ 15-55x52

EVERYONE LOVES A WINNER.

When we introduced this, our first Competition™, it immediately set new standards for long-range performance... much to the dismay of shooters relying upon other brands of riflescopes.

The U.S., Australian and South African F-Class rifle teams quickly adopted it, praising its exceptional clarity and resolving power. Its robust construction allows the 15-55x52 to digest thousands of rounds and always respond like new.

Many professional shooters have labeled it, "the perfect F-Class rifle scope." We'll let you—and your scores—be the judges.

Magnification range	15-55x
Focal plane	Second
Body tube diameter	30 mm
Overall length	16.2"/411 mm
Mounting length	6.4"/162 mm
Weight	27.87 oz/790 g
Click value	.125 MOA
Internal adjustment range	E: 55 MOA W: 50 MOA
Parallax adjustment	25 yd—∞
Eye relief	3.15"/90 mm
Field of view @ 100 yd/m	15x: 6.91 ft/2.10 m 55x: 1.83 ft/0.55 m
Exit pupil	15x: 3.54 mm 55x: 0.93 mm
Illumination	Non-illuminated
Elevation feature	ZeroStop®
Power Throw Lever	NA
Reticles available	CTR-2™ CTR-3™ DDR-2™ FCR-1™



Derek Rodgers is the man to beat, whether it's F-Class or ELR shooting. His resume includes multiple F-Class National Championships, an F-Class World Championship title and winner of the King of 2 Mile competition. Here, Derek is on the line at the Ben Avery Range in Phoenix, AZ with a Competition™ 15-55x52.

COMPETITION™ SR FIXED 4.5x24

SERVICE RIFLE DOMINATION.

The Competition SR Fixed 4.5 x 24 was created with one purpose: to dominate service rifle matches held under both Civilian Marksmanship Program (CMP) and NRA rules.

The SR Fixed 4.5 x 24 complies with new match rules that allow the use of riflescopes having a maximum magnification of 4.5x and an objective lens of 34mm or less. It is compact, light in weight, and repeatable over a lifetime of hard use. Its exposed adjustments provide a full 100 MOA of both windage and elevation travel, and markings are large and easy to read.

It was built to win. And win it does.

Magnification range	4.5x
Focal plane	Second
Body tube diameter	30 mm
Overall length	9.9"/251 mm
Mounting length	6.6"/168 mm
Weight	15.4 oz/437 g
Click value	.250 MOA
Internal adjustment range	E: 100 MOA W: 100 MOA
Parallax adjustment	Fixed @ 200 yds
Eye relief	3.74"/95 mm
Field of view @ 100 yd/m	23.2 ft/7.07 m
Exit pupil	5.3 mm
Illumination	Non-illuminated
Elevation feature	ZeroStop®
Power Throw Lever	NA
Reticles available	SR-1™ SR-2™



The Competition™ SR Fixed 4.5x24 has but one purpose—to win in service rifle competition. It is quickly rewriting the record books among civilian shooters and military competitive rifle teams.

PRECISION BENCHREST 8-32x56 • 12-42x56

BREAKING RECORDS FOR 25 YEARS.



Precision Benchrest 8-32x56



Precision Benchrest 12-42x56

If it seems like products these days are obsolete overnight, with “new and improved” versions introduced every few months, our Precision Benchrest series proves that quality and performance are timeless.

They’ve remained virtually unchanged in the roughly 25 years since we first created them. They’ve been responsible for countless records set, competitions won, and millions of rounds fired.

Favorites of .50 BMG shooters, their ruggedness is beyond question. Outstanding light transmission and crisp, brilliant images allow the shooter to distinguish the finest details at every magnification setting, at extreme ranges.

Our proprietary lens coatings reduce glare, increase contrast, and provide true color rendering. They are just as efficient at maximum magnification as they are at low settings.

If there’s a way to improve Precision Benchrest riflescopes, we will. So far, we haven’t needed to.

	8-32x56	12-42x56
Magnification range	8-32x	12-42x
Focal plane	Second	Second
Body tube diameter	30 mm	30 mm
Overall length	16.6"/422 mm	17"/432 mm
Mounting length	5.5"/140 mm	5.9"/150 mm
Weight	36 oz/1021 g	36 oz/1021 g
Click value	.125 MOA	.125 MOA
Internal adjustment range	E: 50 MOA	E: 40 MOA
	W: 50 MOA	W: 40 MOA
Parallax adjustment	25 yd–∞	25 yd–∞
Eye relief	2.9"/75 mm	2.9"/75 mm
Field of view @ 100 yd/m	8x: 9.4 ft/2.9 m	12x: 6.7 ft/2.0 m
	32x: 3.1 ft/1.0 m	42x: 2.3 ft/0.7 m
Exit pupil	8x: 5.6 mm	12x: 4.0 mm
	32x: 1.7 mm	42x: 1.4 mm
Illumination	Analog	Analog
Elevation feature	Capped, adjustable	Capped, adjustable
Power Throw Lever	NA	NA
Reticles available	NP-R2™	NP-R2™
	NP-2DD™	NP-2DD™

RETICLES

Please note: Reticles offered in certain Nightforce riflescopes may have minor variations from those pictured here. Some reticles are available only in specific riflescopes. Please visit NightforceOptics.com for complete details.

Some reticles are shown enlarged for clarity. For full details visit NightforceOptics.com/reticles.

MOA

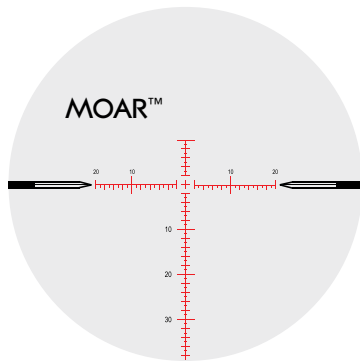

Our most popular MOA-based reticle. Intelligent and highly versatile across almost any shooting application.

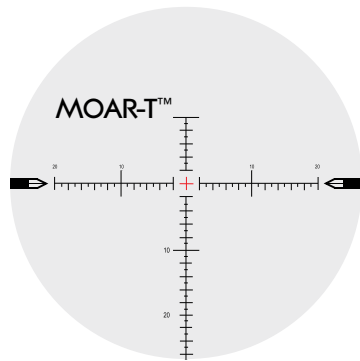

A finer version of our MOAR™, allowing even greater precision at extreme ranges.

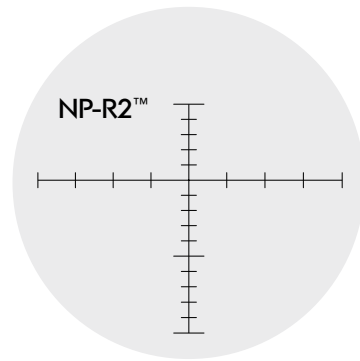

A classic Nightforce MOA reticle, created specifically for long-range applications in our Precision Benchrest models only.

HUNTING

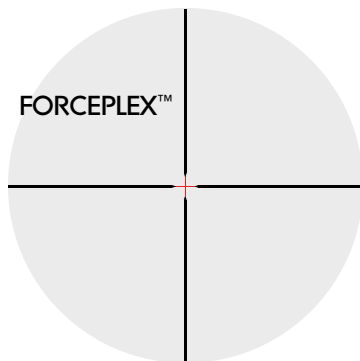

An improvement on traditional fourplex hunting reticles. Clean field of view will not obstruct target. North American riflescopes only.

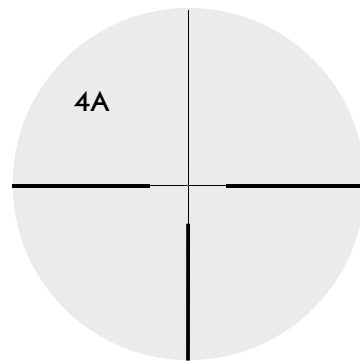

A classic style popular with European hunters for over a century. International markets only.

The mathematics of Minute of Angle

A true MOA is equal to one-sixtieth of one degree, which is 1.047" at 100 yards.

As an angular unit of measurement, the value is not an equal, linear amount at all distances. As such, 1 MOA is 1.047" at 100 yards, 2.094" at 200 yards, 3.141" at 300 yards, etc.

MIL-RADIAN

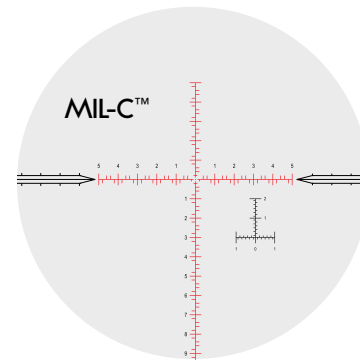

Designed for the Precision Rifle Series competitor and field shooters. Fast and accurate, superb rangefinding capabilities.

HORUS

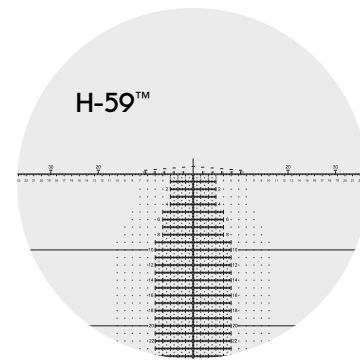

A rapid engagement reticle with multiple hold points and the Accuracy 1st Speed Shooting Formula built in.

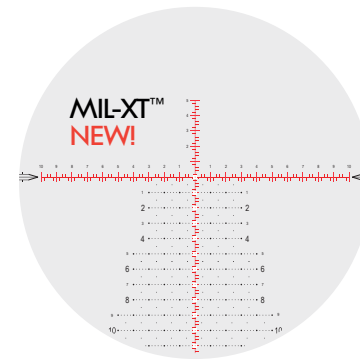

An evolution of the MIL-C™, adding extra hold-over and hold-off markings for rapid target engagements.

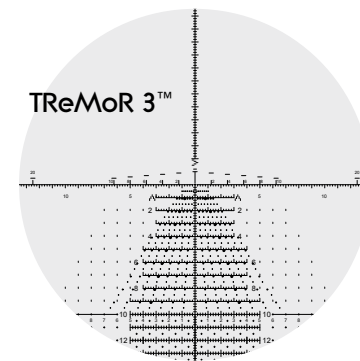

Designed for speed at any distance. Especially helpful in windy conditions. The Accuracy 1st Speed Shooting Formula is built in.

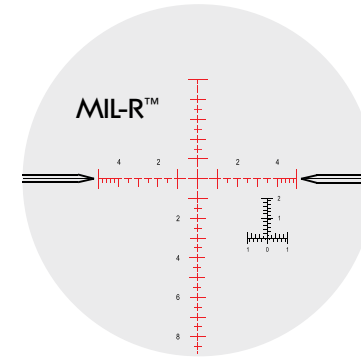

Clean and uncluttered, designed for speed and intuitive shooting, providing precision ranging, accurate hold-offs and quick followup shots.

Mil-Radian measurements

The incremental amount denoted as a Mil-Radian (Mil) is an angular system of measurement. A true Mil is equal to 1/6283 of a circle, or 3.43775 MOA. This equals 3.600" at 100 yards or 10 cm at 100 meters.

As an angular unit of measurement, the value is not an equal, linear amount at all distances. As such, 1 Mil is 3.600" at 100 yards, 7.200" at 200 yards, 10.800" at 300 yards, etc.

H-59 and TRemOR 3™ are trademarks of Horus Vision. Reticle designs © Horus Vision 2018, all rights reserved.

RETICLES

LOW POWER

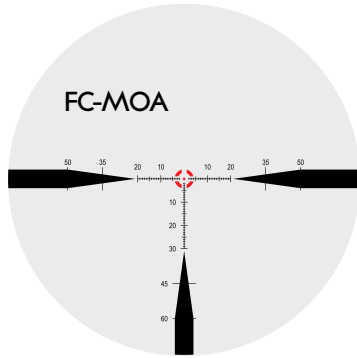

Created and optimized for our low-power variable riflescopes. As first focal plane reticles, elevation and windage markings are valid at every magnification setting, providing precise hold and reference points. The bright daylight center dot is visible under the harshest light. Bold, pointed lines draw the eye to the center of the target.

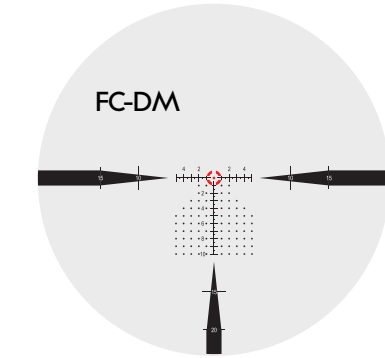
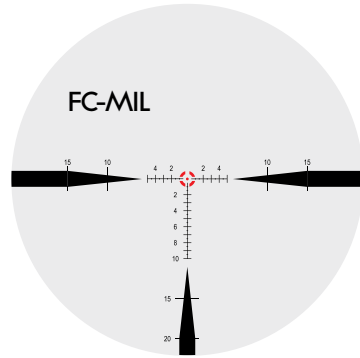

Optimized for low power variable riflescopes with first focal plane reticles. Daylight bright center dot, .5 and 1 Mil markings provide easy hold points for moving targets.

TARGET

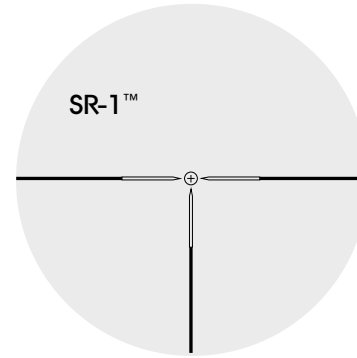

Designed exclusively for our Competition™ SR Fixed 4.5x24, it provides a winning edge at CMP and NRA service rifle matches. Appears familiar to iron sight shooters.

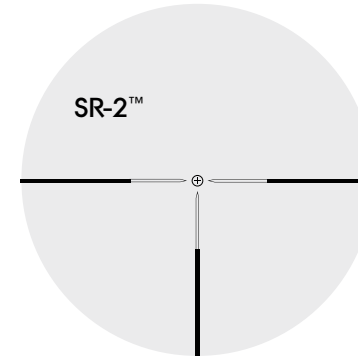

Similar to our SR-1™, but with smaller 10 MOA center circle and 6 MOA crosshairs.

TARGET

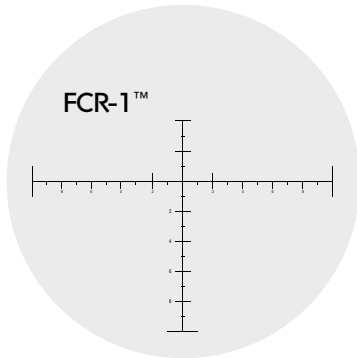

Developed with the help of U.S. F-Class rifle teams. Available in our Competition™ riflescopes.

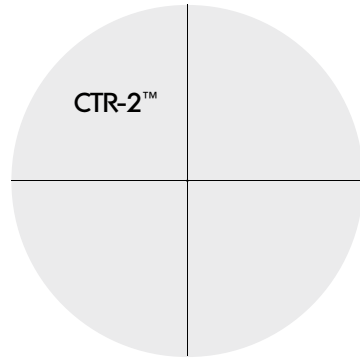

Very fine lines with center dot for target and precision shooting. Competition™ riflescopes only.

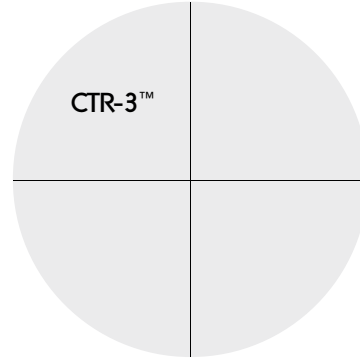

The simplest reticle we offer, having fine .016 MOA lines. Competition™ riflescopes only.

TARGET

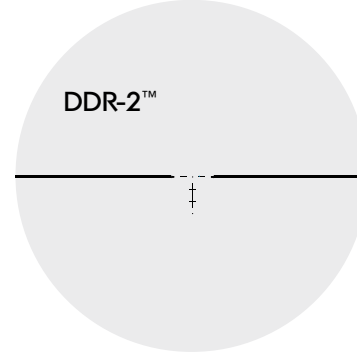

Perfect for the competitor and varmint shooter. .095 MOA center dot, vertical holdover markings. Competition™ riflescopes only.

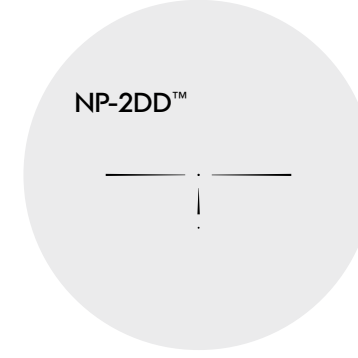

Unobstructed field of view and precise MOA reference markings make the NP-2DD™ ideal for both the varmint hunter and benchrest competitor.

ZeroStop
NIGHTFORCE

After sighting in your rifle, simply set the ZeroStop® according to instructions, and you create a positive mechanical stopping point at your chosen zero point. No matter how many elevation adjustments you make, turning the elevation knob down to the ZeroStop® setting returns you to your original zero, completely by feel.

ZeroHOLD
NIGHTFORCE

A low-profile mechanism utilized on the ATACR™ 4-16x42 F1. It holds the elevation adjustment at zero until the ZeroHold™ button is depressed. It allows an instant return to zero after making elevation adjustments, and also lets the shooter dial below zero.

ZeroSET
NIGHTFORCE

Created for our SHV™ 5-20 x 56 and 4-14 x 50 F1 riflescopes. It provides a quick and efficient means of returning to your zero setting, even after you've made several elevation adjustments.

Digillum

Digital reticle illumination technology is available in select riflescopes. Choose the appropriate illumination setting for your lighting conditions—either red or green, in multiple intensities from very dim to extremely bright.

X-TREME DUTY™ MOUNTS

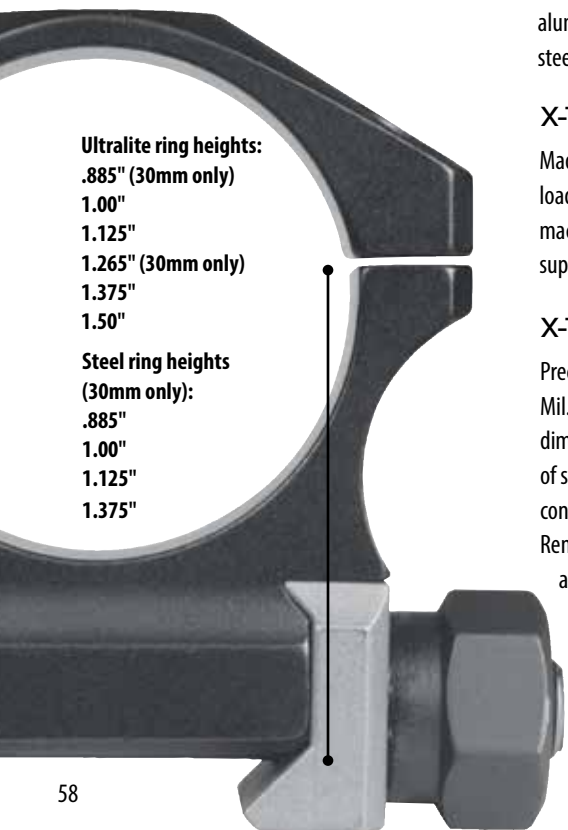

Ultralite ring heights:

.885" (30mm only)
1.00"
1.125"
1.265" (30mm only)
1.375"
1.50"

Steel ring heights

(30mm only):
.885"
1.00"
1.125"
1.375"

The finest riflescope in the world is only as good as its mounts.

Using inferior mounts can cause stress and alignment problems that are extremely difficult to diagnose. Large-caliber rifles producing heavy recoil can also wreak havoc on poor-quality mounts.

X-TREME DUTY™ ULTRALITE™ RINGS

Available in four- and six-screw versions. Machined 7075-T6 hard anodized aluminum with titanium crossbolts and jaw provide the performance of steel at half the weight. Six-screw rings give 50% more clamping force.

X-TREME DUTY™ STEEL RINGS

Made to our own stringent specifications to fit Mil. Std. 1913 bases. A load-bearing recoil lug on the grade eight crossbolt precisely matches the machined cross lug of Nightforce bases, providing perfect alignment and superior accuracy. Four heights for 30mm diameter tubes.

X-TREME DUTY™ STEEL BASES

Precision machined to exact Mil. Std. 1913 specification rail dimensions from a single billet of steel, they match the receiver contour ensuring true alignment.

Rem 700 and Win 70 bases include

an integral recoil lug which provides a precise fit, prevents movement and reduces recoil stress on mounting screws. Standard with a 20 MOA taper, with a 40 MOA taper available for Rem 700 bases. Two-piece configurations available for Remington and Savage actions.



30mm Ultralite™ four-screw



30mm Ultralite™ six-screw



34mm Ultralite™ four-screw



34mm Ultralite™ six-screw



Integral recoil lugs provide rock-solid security on Mil. Std. 1913 receivers.

Front



NIGHTFORCE X-TREME DUTY™ UNIMOUNT™ AND MAGMOUNT™

Available in three heights/30mm diameter:
1.125"
1.375"
1.50"
1.375" Extended

Available in 34mm diameter, 1.44" and 1.5" height in Unimount,™ 1.44" in Extended Unimount.™



The Ultralite™ Extended Unimount™ is designed for shorter receivers and can provide additional eye relief.



When a tough, reliable mounting system is required without adding substantial weight, the Nightforce Ultralite™ Unimount™ and Magmount™ are the answers. It features a CNC machined 7075-T6 hard anodized aluminum body and titanium beta series crossbolts and jaws.

This unique design and construction provides the performance of steel at half the weight. The Nightforce Unimount™ and Magmount™ are designed to remain attached to the scope at all times, allowing quick removal and installation on different firearms.



Magmount™



Compact Magmount™

The Ultralite™ Magmount™ (30mm & 34mm, 1.44" height) and Compact Magmounts™ (34mm only, 1.5" height) add a third crossbolt for greater protection against recoil. They allow clearance of 56mm objective riflescopes when mounted on a continuous rail.

Unimounts™ and Magmounts™ are available for 30 and 34mm riflescopes, and feature a 20 MOA taper (Magmounts are also available with a zero degree taper). The Unimount™ / Magmount™ is the ultimate mount for attaching to weapons with an integral Mil. Std. 1913 flat top-type receiver.

Precise tolerances ensure that the riflescope is not subjected to stress, strain, or bending as the ring screws are tightened.

NIGHTFORCE RINGTOP ACCESSORIES



Top ring Bubble Level shown installed.

TOP RING BUBBLE LEVEL

Replaces the top ring of our 30mm and 34mm Unimount™, Direct Mount™, Magmount™ and Ultralite™ rings and 30mm steel rings.

RAP™

Our Ruggedized Accessory Platform (RAP) provides four inches of rail space above your rifle scope for mounting of accessories. The RAP is optimized to withstand heavy recoil and still maintain zero even delicate accessories or sensors. *Designed to fit four- and six-screw X-Treme Duty™ rings and Unimounts.™*



MULTIMOUNT™

Originally designed as a platform for close-range sights to be mounted in conjunction with a primary rifle scope. In practice, the MultiMount offers a user-configurable system that is rock solid for nearly any accessory that will fit. *Designed to fit 4- and 6-screw X-Treme Duty™ rings. Two Mil. Std. 1913 rails included.*



ESSENTIALS



NIGHTFORCE TOOL KIT

The majority of accuracy problems we encounter are caused not by the scope, but by poor scope mounts and/or improper mounting techniques.

The 10-piece Nightforce Tool Kit includes high-quality torque limiters, bits and drive tools to allow adjustment of mounting screws and components to recommended torque settings. Having the correct torque values ensures your scope will stay in place during use, and prevents over-tightening which can damage scopes and affect accuracy.

These precision tools come in a zippered storage case that fits nicely inside a range bag.



NIGHTFORCE CLEANING KIT

Improperly cleaning a rifle scope can permanently damage lens elements and lens coatings. Plus, a properly cleaned scope will give you maximum optical performance and clarity.

The 12-piece Nightforce Cleaning Kit comes packed in a handy carrying case. It includes everything you need plus instructions for proper care and cleaning of fine optics.

Highly recommended to protect your investment and to keep your rifle scope performing at its best.

MOUNTS

STANDARD DUTY

Standard Duty Rings

- .90"
- 1.00"
- 1.25"
- 1.50"



STANDARD DUTY RINGS

An ideal combination of durability and value. Straightforward two-screw design simplifies installation and requires less front-to-back space, for applications where installation choices are limited. The positive locking jaw design and machined recoil lug provide perfect alignment for superior accuracy when mounted to Mil. Std. 1913 bases. Offered in four heights for 30mm diameter tubes. An excellent mounting solution when partnered with a Standard Duty or X-Treme Duty™ base.

STANDARD DUTY BASES



Nightforce Standard Duty bases are a quality, affordable solution for ensuring that your scope is firmly mounted to your rifle. These aluminum bases are machined to Mil. Std. 1913 rail specifications and hard anodized.

Available for a wide variety of firearms, including:

Browning A-Bolt • Howa 1500 • Kimber 84 & 8400 • Mauser 98 Large Ring • NEF/HNR Handi Rifle • Remington 700 & XP100 • Ruger American • Ruger 10/22 • Savage Round & Flat Actions Savage Mk II, 64 & 93 Rimfire • T/C Contender & Encore • Tikka T3 & 595 • Weatherby Vanguard & MkV • Winchester 70 & 52 Target

GUNSMITH BASES



Offered in steel or aluminum alloy. These Mil. Std. 1913 base blanks allow you to customize the length, height, radius and hole spacing to your specific application. Standard taper is 20 MOA.

OTHER ACCESSORIES

Nightforce X-Treme Duty™ Direct Mount™

More reliable and up to 45% lighter in weight than traditional mounting systems, it is ideal for both short or long Remington 700 actions. Its one-piece design ensures true alignment and maximum strength.



The base and integral rings are CNC machined to precise tolerances from 7075-T6 hard anodized aluminum, providing exceptional strength while reducing weight. A 20 MOA taper maximizes internal riflescope adjustment and long-range capability. It incorporates an integral recoil lug which prevents any movement of the base or stress on the screws while subjected to harsh recoil. 30 mm diameter, offered in .885, 1.0 and 1.125 inch heights.

Nightforce Clamp-On PTL™

Our Power Throw Lever fits Nightforce NXS™ full size and non-enhanced Compact models, plus legacy ATACR™ and SHV™ riflescopes. It allows instant magnification changes, even while wearing gloves. Easily removed.



Nightforce Flip-Up Lens Caps

Protects your riflescope lenses from damage and weather, without interfering with quick shots.



Lens Covers and Sunshades

Sunshades reduce glare, while lens covers provide maximum protection while transporting your rifle and riflescope.



Nightforce Torque Wrench

The perfect tool to ensure tightening components to recommended specifications. Equal to 68 inch/lbs.



NIGHTFORCE SPOTTING SCOPES

Our **TS-82™ Xtreme Hi-Def™ 20-70x** spotting scope meets—and exceeds—the quality, resolution, brilliance, and fidelity of the world's most well-known, most highly respected European spotting scopes, many of which come with much higher price tags.

HD fluorite glass, found in only the very finest spotters, provides the truest, most brilliant color and razor-sharp resolution.

If you have never used a world-class spotting scope, you are in for an eye-opening experience. Literally.



**TS-82™
XTREME HI-DEF™
20-70X**

The TS-82™ is offered with straight or angled eyepieces.



**TS-80™ HI-DEF™
20-60X**



An extensive line of accessories is available for the TS-82™ including rugged, handsome carrying cases and heavy-duty protective sleeves.

The **TS-80™ Hi-Def™ 20-60x** offers a combination of value and performance you simply won't find elsewhere. Lenses of premium ED glass provide bright, crisp images. Its superior optical design results in excellent light transmission. And, like all Nightforce products, it stands up to the harshest of field conditions.

You'll enjoy optical performance you must see to fully appreciate... at a price you'll appreciate every day.

Visit NightforceOptics.com for more information.

	TS-82™	TS-80™
Magnification range	20-70x standard	20-60x (non-removable)
Objective diameter	82mm	80mm
Lens coatings	Fully broadband multi-coated	Fully broadband multi-coated
Main body material	Magnesium alloy	Magnesium alloy
Eyepiece outer diameter	1.87"/47.5mm (1.89"/48mm eyecup dia)	2.20"/56.0mm (2.24"/57mm eyecup dia)
Weight (oz.)	63	68
Waterproof	Yes	Yes
Nitrogen purged	Yes	Yes
Focus	Barrel	Barrel
Focus rotations, 6 m to ∞	1 3/4 turns	Two
Eyecup	Twist-up, removable	Twist-up, removable
Tripod platform	Magnesium	Magnesium
Armoring	Full rubber	Full rubber
Protective caps	Eyepiece and objective lens covers	Eyepiece and objective lens covers
Tripod thread:	1/4-20	1/4-20
Standard eyepiece	20-70x	20-60x
Optional eyepiece	30-60x wide angle	NA
Exit pupil	4.10–1.17 mm	4.00–1.33 mm
Eye relief	18 mm	18.5 mm
Field of view	20x: 12.3 ft @ 100 yds 70x: 4.9 ft @ 100 yds	20x: 10.5 ft @ 100 yds 60x: 5.7 ft @ 100 yds

SPOTTING SCOPE ACCESSORIES



Carrying Case

Carries your spotting scope and accessories. Available individually or as a kit that includes spotting scope, eyepiece, protective sleeve, cleaning kit, fob lens cloth, and grommet kit.



Heavy-Duty Sleeves

Add protection to your spotter without compromising functionality.



30-60 x Wide Angle Eyepiece

Wider field of view allows easy tracking of moving animals and birds. (TS-82™ only)



Mil-Std. 1913 Rail

Allows attachment of a wide range of accessories.

THE NIGHTFORCE TRIPOD

We designed our professional-quality tripod as the perfect platform for our spotting scopes. But that was just the start. Why not also make it an ideal shooting rest? And why not allow it to be quickly transformed into a monopod? What if the legs could morph into sturdy, adjustable trekking poles?

And let's build it of carbon fiber, the most advanced, durable, lightweight material available.

It is the most complete system ever developed for the hunter, shooter, hiker, photographer, and videographer.



Center column bottom hook allows attachment of weight for maximum stability in high winds.



Professional ball head with quick-release universal plate allows unlimited silky-smooth pans and tilts. Standard 1/4"-20 mounting screw. Supports weights up to 17.5 pounds.

Extends to 64" height, minimum usable height a mere 9".

Carbon fiber construction is extremely strong and lightweight, just 3.6 pounds.

Taking a hike? Two legs quickly convert into sturdy, adjustable trekking poles.

Use one leg as a monopod for a sturdy shooting or viewing platform when maximum portability is necessary.



NIGHTFORCE MIL-SPEC

BUILT TO GO INTO HARM'S WAY. AND BACK.

Nightforce MIL-SPEC riflescopes are built and tested to withstand the rigors of modern combat, ensuring utter reliability and performance under the most demanding conditions. They will withstand rapid pressure changes such as a HALO or SCUBA insertion, and endure the harsh conditions of extended operations.

Their optical clarity and virtually indestructible construction give the edge to the good guys.

Nightforce MIL-SPEC riflescopes and accessories are ready to serve at a moment's notice.

- **All air-to-glass surfaces** receive our proprietary broadband multi-coating, exceeding the toughest MIL-SPEC abrasion test.
- **Mechanical components** retain their integrity when exposed to extreme shock and vibration.
- **All critical optical elements** are bedded in our proprietary MIL-SPEC bonding agent, reducing glass-to-metal contact.
- **Tracking and dial accuracy**, reticle tilt, maximum adjustment range, between-power deviation and adjustment backlash are held to tolerances unmatched by any other scope manufacturer.

Nightforce MIL-SPEC ATACR™ 1-8x24 F1 riflescopes were chosen by US SOCOM for their Squad Variable Powered Scope program. Nightforce MIL-SPEC ATACR™ 5-25x56 F1 riflescopes are currently in service with the U.S. Marine Corps on their Mk13 Mod 7 sniper rifles. Nightforce scopes have served with almost every branch of the United States Military.



- **Every MIL-SPEC rifle scope** must pass a pressure test simulating an underwater depth of 100 feet, exceeding current U.S. military specifications by up to 25%.
- **Pressure testing** guarantees that all MIL-SPEC riflescopes are airtight, ensuring the integrity of internal components against the effects of rapid temperature and pressure fluctuations encountered by HALO (High Altitude, Low Opening) troop insertions, and covert waterborne insertions at submarine depth.
- **Impact testing** on multiple axes ensures that each rifle scope can withstand battlefield abuse.
- **Each MIL-SPEC rifle scope** is individually inspected and tested to guarantee consistency, repeatability and integrity at every stage of the manufacturing process.

Nightforce offers custom configurations to meet the needs of the professional end user. MIL-SPEC riflescopes are not available to the general public. Contact the Nightforce MIL/GOV/LE department for more information.

WARRANTY

A WARRANTY IS NO SUBSTITUTE FOR INHERENT QUALITY.

Some companies promise all kinds of things with their warranties... like full replacements for any reason. If you think about it, you have to wonder just how well such products are made in the first place, and what kind of markup you're paying to make such things possible.

A "free replacement" won't do you much good if your scope fails during an expensive hunt halfway around the world, if it costs you a trophy or your best chance at a world record, or if you're trusting it with your life in combat.

We think the best warranty is one you'll never have to use. The fact is, far less than 1% of the scopes we build are ever returned for warranty service.

Yes, all Nightforce riflescopes are covered by a transferable Limited Lifetime Warranty. If we did something wrong, we'll fix it.

We figure it's far better to build a riflescope as close to perfect as humanly possible in the first place.

SERVICE

REAL, EXPERT SERVICE.
NOT LIP SERVICE.

We have a full-time, in-house customer service staff available to you should you need help before or after your purchase. Our customer service team is comprised of experienced shooters, hunters, and experienced factory technicians that are ready and willing to help with questions on choosing the right product, applications, how-tos, fitment or any concerns you might have.

We also enjoy hearing about your successes in the field or on the range, so don't hesitate to call. And we love seeing photos.

You can reach our Customer Service Team at:

Phone: **208.476.9814 ext 3**
Email: **info@nightforceoptics.com**
Postal: **336 Hazen Lane, Orofino, ID 83544**



ABOUT LENS COATINGS

Almost every riflescope manufacturer claims "multi-coated" lenses. By itself, that doesn't mean much. The finest coatings, such as those used on Nightforce lenses, are highly sophisticated, proprietary chemical compositions. They can be tailored to transmit certain wavelengths of light that are more visible to the human eye at dawn and dusk, and modified to complement specific types of glass.

Good lens coatings will help reduce glare and greatly influence the accuracy of the color in the image you see.

So, when you hear about "multi-coated" lenses, take it with a grain of salt. Cheap coatings provide little benefit. Good lens coatings are costly and difficult to apply. We use them, though, because they work.

CONTACT US

Factory/Headquarters and Customer Service

Nightforce Optics
336 Hazen Lane
Orofino, ID 83544
tel 208.476.9814
info@nightforceoptics.com

North American Sales

Nightforce Optics
2749 Providence Church Road
Lavonia, GA 30553
tel 800.732.9824 ext 8440
dealersales@nightforceoptics.com

MIL-GOV-LE

Nightforce Optics
2749 Providence Church Road
Lavonia, GA 30553
tel 800.732.9824 ext 8420
militaryinfo@nightforceoptics.com

International Sales

Nightforce Optics
2749 Providence Church Road
Lavonia, GA 30553
tel 800.732.9824 ext 8410
intlsales@nightforceoptics.com

Marketing

Nightforce Optics
2749 Providence Church Road
Lavonia, GA 30553
tel 800.732.9824 ext 8430
marketing@nightforceoptics.com

Get the latest news, tech tips, and good stories via our newsletter at www.NightforceOptics.com/newsletter

Find a Nightforce dealer near you at www.NightforceOptics.com

Export Compliance

Riflescopes, spotting scopes and accessories listed within are controlled for export by the U.S. Department of State, under the International Traffic In Arms (ITAR) regulations (22 CFR, Parts 120-130), and/or the Department of Commerce under the Bureau of Industry and Security Export Administration Regulations (15 CFR, Parts 730-774). To export products outside of the United States of America, you must comply with the regulatory agency's license and documentation requirements.



NIGHTFORCE
www.NightforceOptics.com
LightFORCE
PERFORMANCE LIGHTING
A Lightforce company

 facebook.com/NightforceOptics

 instagram.com/Nightforce_Optics

 youtube.com/NightforceOptics

Lightforce USA, Inc., dba Nightforce Optics.

© Nightforce Optics 2019 1/19 All information herein is accurate at time of printing.

Specifications and product appearances subject to change without notice.

All trademarks, graphics and designs herein are the property of Nightforce Optics.



NIGHTFORCE

Lightforce USA, Inc., dba Nightforce Optics

©Nightforce Optics 2019