

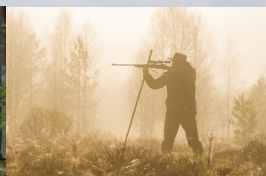

ENG



# A BETTER VIEW OF THE WORLD



EUROPEAN  
OPTICS  
since  
1933

**MEOPTA**  
Reticles (in metric units)



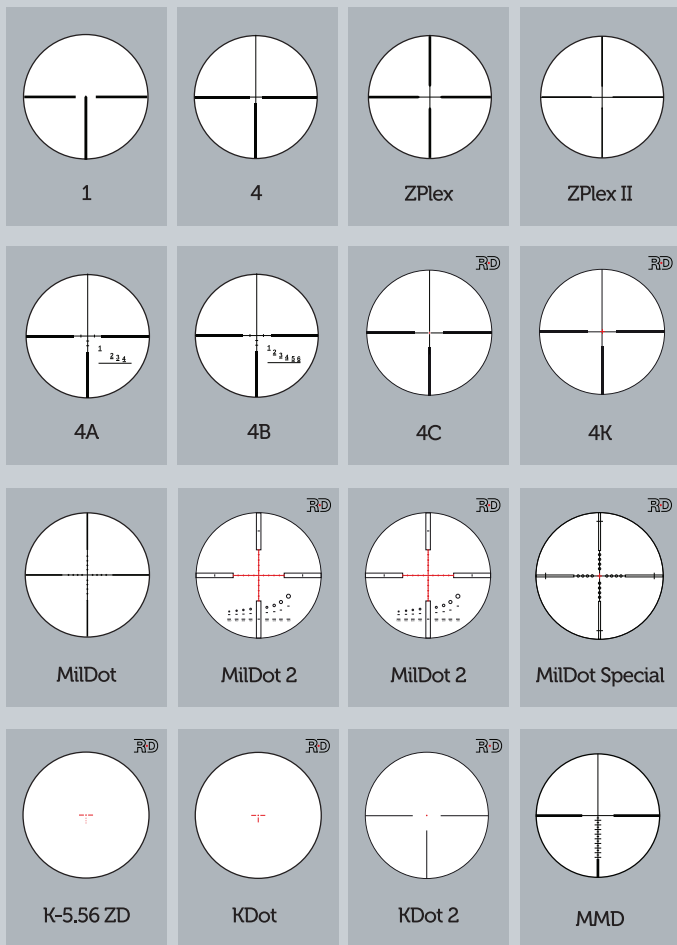

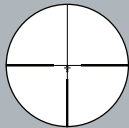

BDC



MW MV



MW HV

## MEOPTA Reticle selection & Usage

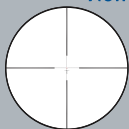

BDC 2

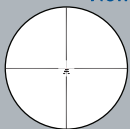

BDC 3

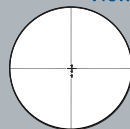

MilDot 03

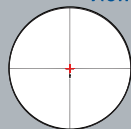

MilDot 04

## Reticle Placement

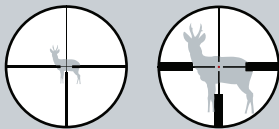
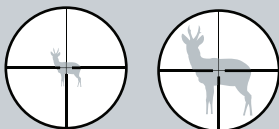
Reticle in the front (1<sup>st</sup>) focal planeReticle in the rear (2<sup>nd</sup>) focal plane

Position of the reticle (crosshairs) in the front focal plane (behind the objective lens) means that with change in magnification both the target image and the reticle thickness increase or decrease. Position of the reticle in the rear focal plane (in front of the eyepiece) allows the reticle to maintain its constant virtual size throughout the entire magnification range.

So shortly:

- All fixed magnification riflescopes are not affected by the reticle position.
- A reticle positioned in the front focal plane enables the shooter to use the distance estimation scale and dimensions of thick lines for measuring distance at any magnification.

## Reticle Placement

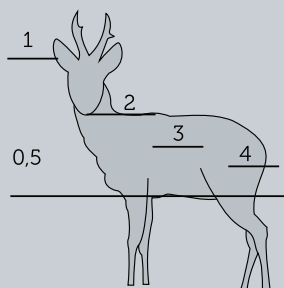

### Use of the distance scale with 4A and 4B reticles

Distance scales help users estimate the distance of an object depending on its size. Line up the target or a part of the target, the size of which you estimate to be 0.5m on the bottom line in the ranging scale. The number that coincides closest with the top of the animal's back indicates its distance in hundreds of meters. For example, if the body trunk height of an adult Roebuck is estimated to be 0.5 m, then this Roebuck, as seen in the illustration, is approximately 200 meters away from the shooter. The 4A ranging reticle allows for range estimation out to 400 meters, while the 4B adds extended distance to 600 meters.

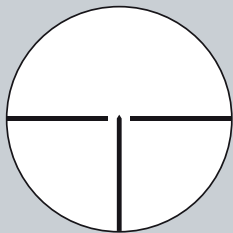

1

Classic European reticle designed for low-light shooting and accurate target acquisition. The pointed center-post provides a solid, sharp point of reference on the intended target.

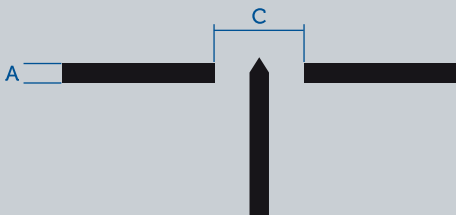

RETICLE	Dimensions (cm/100m)		RETICLE	Dimensions (cm/100m)	
	A	C		A	C
1			1		
Artemis 2000 7x50	20	70	MeoStar R1 1-4x22 (4x)	20	70
Artemis 2000 4x32			MeoStar R1 7x56		
Artemis 2000 6x42			MeoStar R1 4-12x40 (4x)		
Artemis 2000 1.5-6x42			MeoStar R1 3-10x50 (4x)		
Artemis 2000 2-8x42			MeoPro 6x42		
Artemis 2000 3-9x42			Artemis 2000 3-12x50	12	70
Artemis 3000 3-9x42 (4x)			MeoStar R1 3-12x56		
Power for valid dimensions in brackets					

4

Time tested reticle and favorite of many hunters for fast target acquisition and lower light applications.

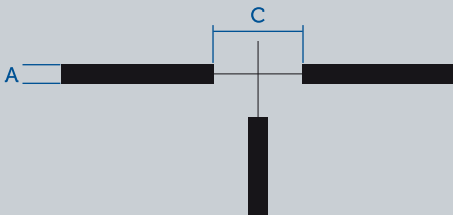
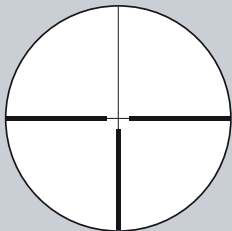

RETICLE	Dimensions (cm/100m)		RETICLE	Dimensions (cm/100m)	
	A	C		A	C
4	A	C	4	A	C
Artemis 2000 7x50	20	70	MeoStar R1 4-12x40 (4x)	20	70
Artemis 2000 4x32			MeoStar R1 3-10x50 (4x)		
Artemis 2000 6x42			MeoPro 3-9x42 (4x)		
Artemis 2000 1.5-6x42			MeoPro 4-12x50 (4x)		
Artemis 2000 2-8x42			MeoPro 6x42		
Artemis 2000 3-9x42			MeoPro 3-9x50 (4x)		
Artemis 3000 3-9x42 (4x)			Artemis 2000 3-12x50	15	70
MeoStar R1 1-4x22 (4x)			MeoStar R1 3-12x56		
MeoStar R1 7x56			MeoPro 3.5-10x44 (4x)	20	140
Power for valid dimensions in brackets					

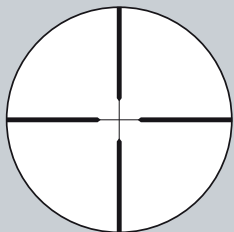

## ZPlex

Very popular all-purpose reticle featuring medium weight posts and fine crosshairs. Wide range of hunting applications.

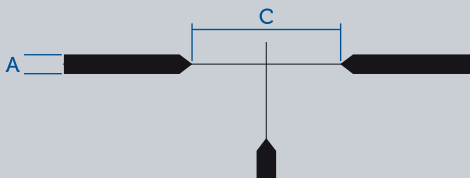

RETICLE	Dimensions (cm/100m)		RETICLE	Dimensions (cm/100m)	
	A	C		A	C
ZPlex	A	C	ZPlex	A	C
Artemis 2000 7x50	7	44	Artemis 2000 2-8x42	20	119
Artemis 2000 4x32	8	100	Artemis 2000 3-9x42	18	107
Artemis 2000 6x42	5	33	Artemis 2000 3-12x50	13	80
Artemis 2000 7x50	5	29	Meostar R1 7x56	8	46
Artemis 2000 1.5-6x42	25	155	Meostar R1 3-12x56	13	79

## ZPlex II

Features thinner posts and fine crosshairs for reduced target obstruction. For hunting, varmint and target applications.

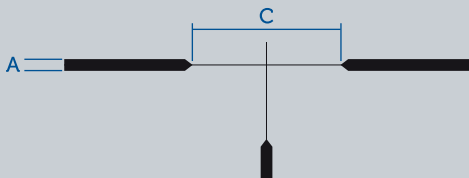
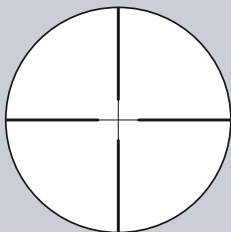

Reticle	Dimensions (cm/100m)		Reticle	Dimensions (cm/100m)			
	A	C		A	C		
ZPlexII	A	C	ZPlexII	A	C		
Artemis 3000 3-9x42 (4x)	4	52	MeoStar R1 4-16x44 (16x)	1	13		
Artemis 3000 1.5-5x20 (4x)			MeoPro 6x42 (6x)	3	34		
MeoStar R1 1.5-5x20 (4x)			MeoPro 6-18x50 (6x)	2	24		
MeoStar R1 1-4x22 (4x)			5	50	MeoPro 3-9x42 (4x)	5	50
MeoStar R1 4-12x40 (4x)					MeoPro 4-12x50 (4x)		
MeoStar R1 3-10x50 (4x)					MeoPro 3-9x50 (4x)		
			MeoPro 3.5-10x44 (4x)				
Power for valid dimensions in brackets							



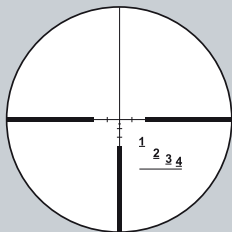

#### 4A

Meopta proprietary ranging and ballistic compensation reticle. Place the baseline marker bar parallel to the animal's belly as shown in the reticle above. The numbered distance bar that falls closest to the top of the animal's back indicates the approximate distance in hundreds of yards. Animal shown is approximately 200 meters out. Marker bars on the lower vertical post as holdovers for extended distances.

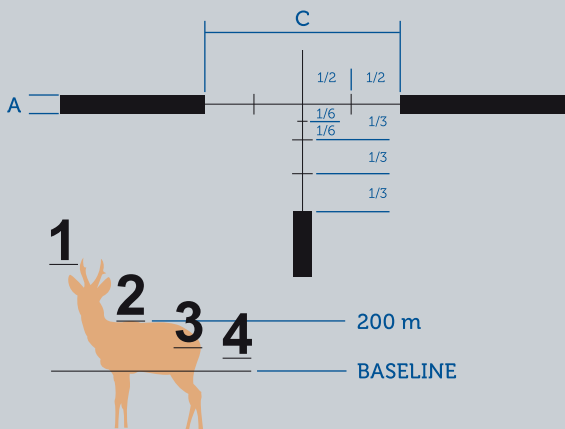

RETICLE	Dimensions (cm/100m)	
4A	A	C
Artemis 2000 4x32	20	140
Artemis 2000 1.5-6x42		
Scale up to 400 m		

### 4B

Meopta proprietary ranging and ballistic compensation reticle. Place the baseline marker bar parallel to the animal's belly as shown in the reticle above. The numbered distance bar that falls closest to the top of the animal's back indicates the approximate distance in hundreds of yards. The animal shown is approximately 200 meters out. Marker bars on the lower vertical post as holdovers for extended distances.

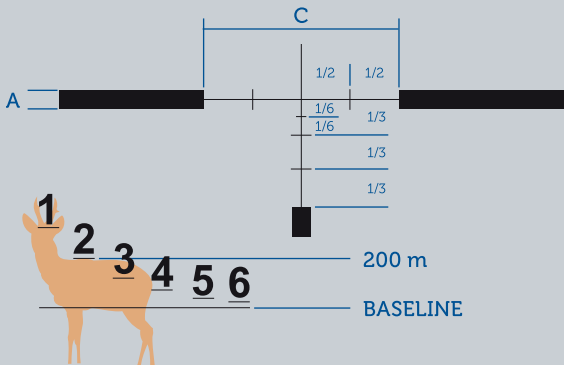
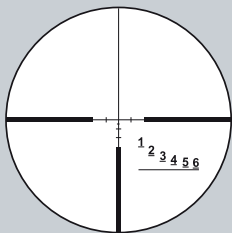

RETICLE	Dimensions (cm/100m)		RETICLE	Dimensions (cm/100m)	
4B	A	C	4B	A	C
Artemis 2000 7x50	20	140	Artemis 2000 3-9x42	20	140
Artemis 2000 6x42			MeoStar R1 7x56		
Artemis 2000 7x50			15	140	Artemis 2000 3-12x50
Artemis 2000 2-8x42					MeoStar R1 3-12x56
Scale up to 600 m					

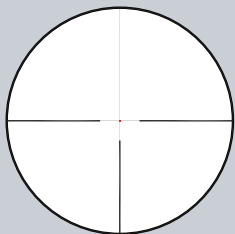

### 4C

RD illuminated.

European style reticle Provides hunters with fast target acquisition in lower light and against tangled backgrounds.

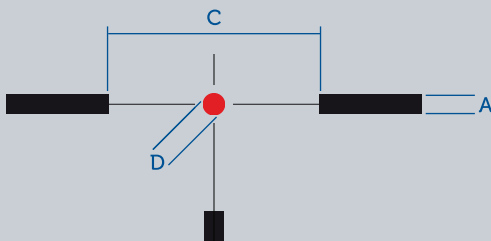

Reticle	Dimensions (cm/100m)			Reticle	Dimensions (cm/100m)		
	A	C	D		A	C	D
4C				4C			
Artemis 2100 7x50 RD	13	62	3.6	MeoStar R1r 3-12x56 RD/MR* (4x)	20	140	5.6
MeoStar R1 7x56 RD		63		MeoStar R1r 3-12x56 RGD* (4x)			
Artemis 2100 3-12x50 RD	15	140	4	MeoStar R2 1-6x24 RD (6x)	10	140	5
MeoStar R1 3-12x56 RD*				MeoStar R2 2.5-15x56 RD (6x)			
MeoPro 3.5-10x44 RD (4x)	20	140	6	MeoStar R2 1.7-10x42 RD (6x)	5	140	2,3
MeoStar R1r 3-12x56 RD* (4x)	20	140	5.6	MeoStar R2 2-12x50 RD (6x)			
MeoStar R1 1.5-6x42 RD (4x)	20	140	2.8				
Power for valid dimensions in brackets							

\*) Till 2011 is the dimension C = 70 cm/100m

## 4K

RD illuminated.

Larger center gate provides hunters with extremely fast target acquisition in lower light and daylight.

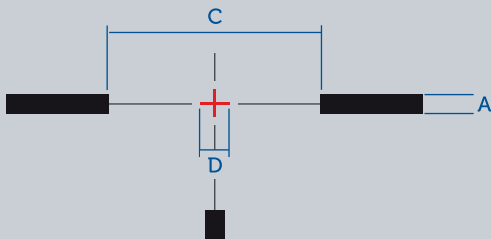
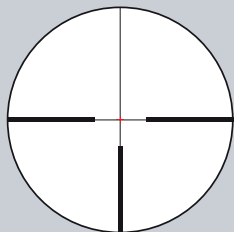

Reticle	Dimensions (cm/100m)		
	A	C	D
<b>4K</b>			
MeoStar R1r 3-12x56 RD* (4x)	20	140	15
MeoStar R1r 3-12x56 RD/MR* (4x)			
MeoStar R2 2.5-15x56 RD (6x)	10	140	10
MeoStar R2 1.7-10x42 RD (6x)			
MeoStar R2 2-12x50 RD (6x)			
Power for valid dimensions in brackets			

\*) Till 2011 is the dimension C = 70 cm/100m

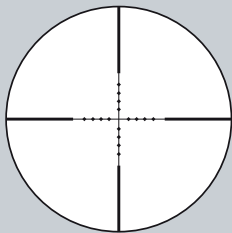

## MilDot

Originally used by the Marines this reticle is useful for estimating range, hold-over and windage. For long distance target shooters and hunters needing basic ranging capability.

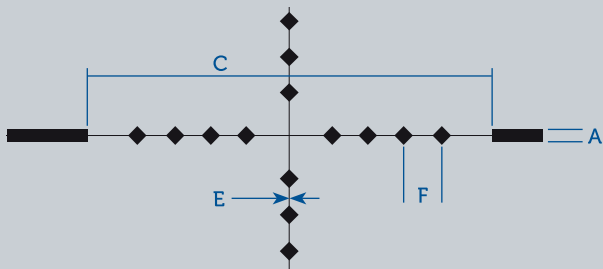

## USE OF MILDOT RETICLES

Similar to the use of distance scale of 4A and 4B reticles, the dots placed on the stadia equal an angle of 1m at 1000m, or 1 milliradian. The distance  $D$  is then determined by a simple calculation using the formula  $D=1000 \times H/h$ , where  $H$  stands for the actual target height in meters and  $h$  stands for its angular height in scale intervals. The above method of range finding provides correct results only with riflescope set on the maximum magnification.

RETICLE	Dimensions			
	(cm/100m)			(mRad)
MilDot	A	C	E	F
MeoStar R1 4-16x44 (16x)	5	100	0.3	1
MeoPro 6-18x50 (18x)				
Power for valid dimensions in brackets				

## MilDot2

RD illuminated.

Tactical ranging MilDot2 for increased accuracy and precision.

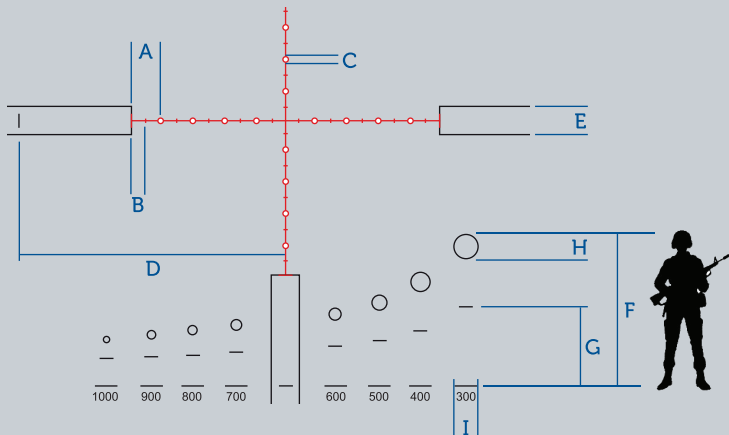
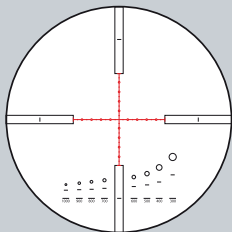

RETICLE	Dimensions (in mrad)				Dimensions (m/distance(x) [m])		
MilDot2	A, E, I	B	C	D	F	G	h
ZD 6-24x56 RD	1.00	0.50	0.20	10.00	1.82	1.00	0.25
Dimensions are valid for 12x power							

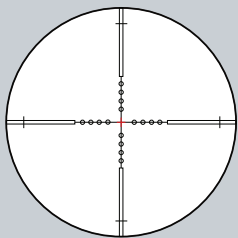

### MilDot Special

Illuminated reticle for estimating range, hold-over and windage at long ranges.

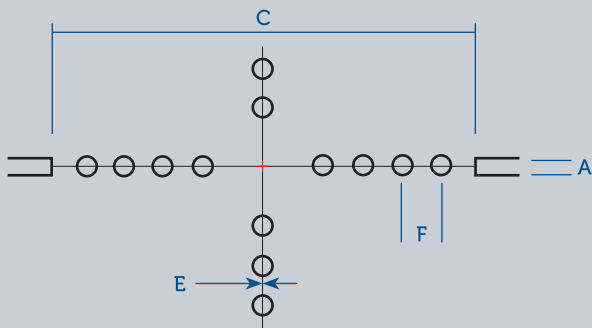

RETICLE	Dimensions			
	(mRad)		(mRad)	
MilDot Special	A	C	E	F
ZD 4-16x44 (14x)	0.2	6.4	0.02	1
Power for valid dimensions in brackets				

## K-5.56 ZD

RD illuminated.

This reticle was designed specifically for the 5.56 NATO ammunition, the chevrons correspond to distances shown in the table below. K-5.56 is also suitable for other calibers and ammunition, as indicated in the table.

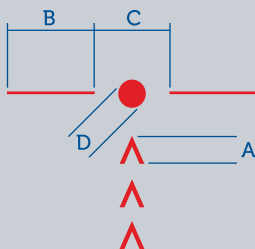
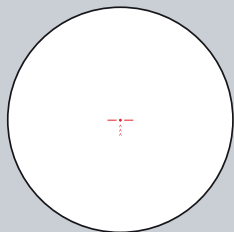

RETICLE	Dimensions (MOA)			
K-5.56 ZD	A	B	C	D
ZD 1-4x22 RD	1.9	9.1	6	2
Dimensions are valid for 4x power				

	Nb 5.56x45mm	7.62x39mm	up to 223 REM.	Chevron Distance (in MOA)
Central Dot	100 m	100 m	100 m	0
1 <sup>st</sup> chevron	300 m	220 m	300 m	4.58
2 <sup>nd</sup> chevron	400 m	290 m	370 m	7.98
3 <sup>rd</sup> chevron	500 m	360 m	480 m	12.11



**KDot**

RD illuminated.

A distinct 2 MOA center dot stands out in harsh lighting conditions making the KDot an excellent driven hunt and fast shooting reticle choice.

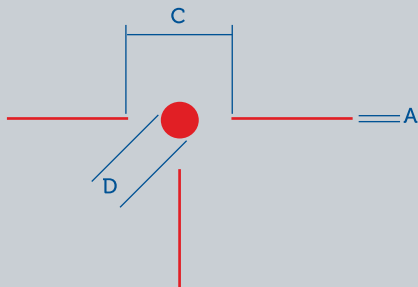
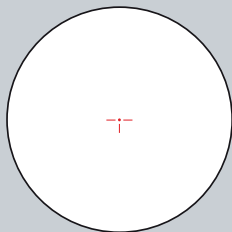

Reticle	Dimensions (cm/100m)		
	A	C	D
MeoStar R1 1-4x22 RD	0.9	18	6
Dimensions are valid for 4x power			

## KDot2

RD illuminated.

The next level of fast shooting, driven game hunting reticles, the KDot2 incorporates a robust center red dot framed by distinctive horizontal and vertical guide lines.

Makes for quick target acquisition on wild boar or dangerous game simple and accurate.

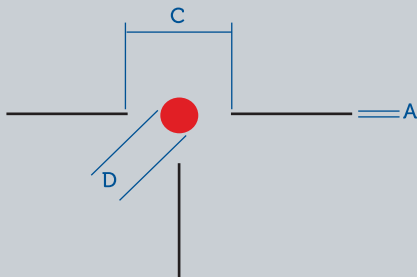
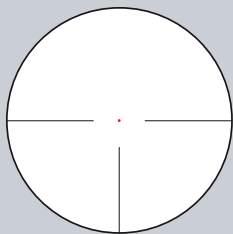

Reticle	Dimensions (cm/100m)		
	A	C	D
KDot2			
MeoStar R2 1-6x24 RD	0.5	140	5
Dimensions are valid for 6x power			

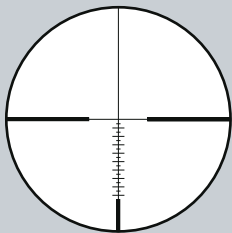

## MMD

Designed specifically for the MeoPro series of riflescopes, the MMD reticle offers Mil Radian measurements and holdover markings on the center post for shooting at extended distances.

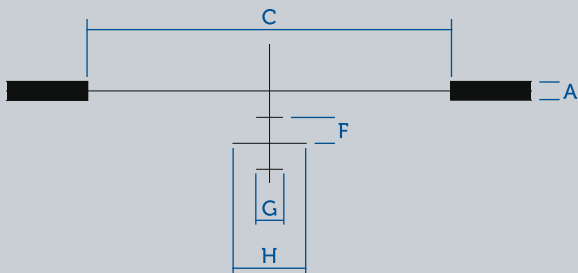

Reticle	Dimensions (cm/100m)				
	A	C	F	G	H
MMD					
MeoPro 3-9x42	5	140	10	10	30
MeoPro 4-12x50					
MeoStar R1 4-12x40					
Dimensions are valid for maximum power					

## BDC

Provides accurate holdovers for 200, 300, 350, 400, 450 and 500 yards out. @ maximum magnification (1 yard = 0.9144 m).

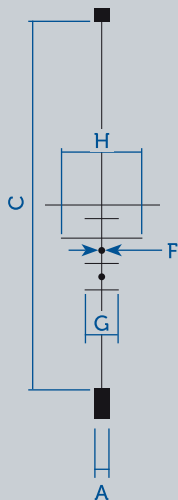
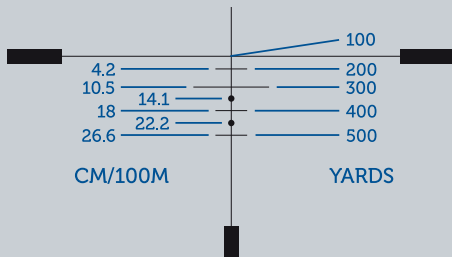
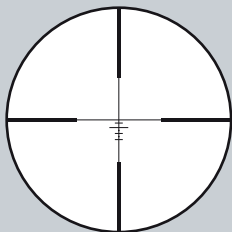

Reticle	Dimensions (cm/100m)				
	A	C	F	G	H
BDC					
MeoPro 3-9x42	4	122	1.8	8.1	23.4
MeoPro 3.5-10x44					
MeoPro 3-9x50					
MeoPro 4-12x50					
MeoPro 6-18x50					
Dimensions are valid for maximum power					

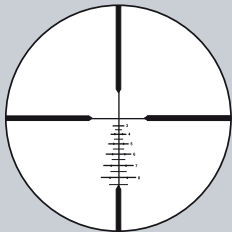

### McWHORTER MV

Meopta medium velocity ballistic compensation reticle.

The McWhorter MV is in the MeoStar R1 3-12x56 and is in the 1st focal plane and is true at all powers.

Designed for a .308 projectile with a BC of .508 at 3000 FPS.

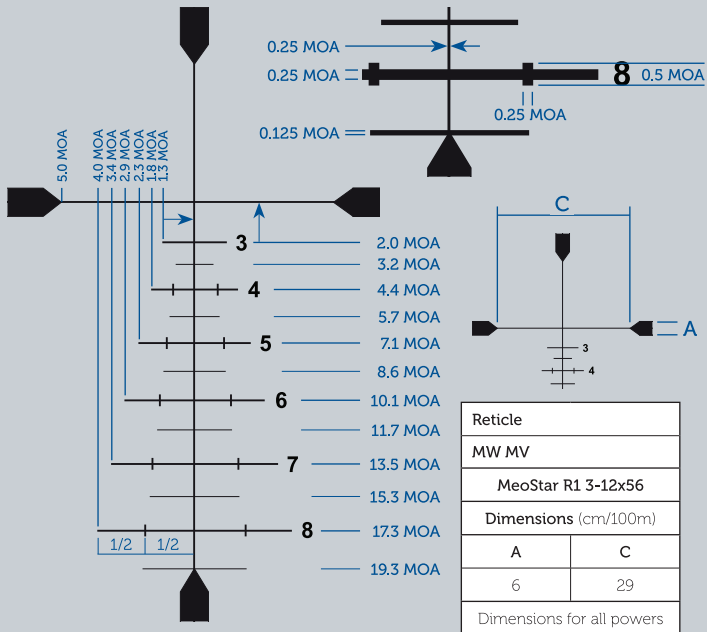

## McWHORTER HV

Meopta high velocity ballistic compensation reticle.

The McWhorter HV is in the MeoStar R1 4-16x44 and optimized at 15x.

Designed for .264 projectile with a BC of .612 @ 3225 FPS.

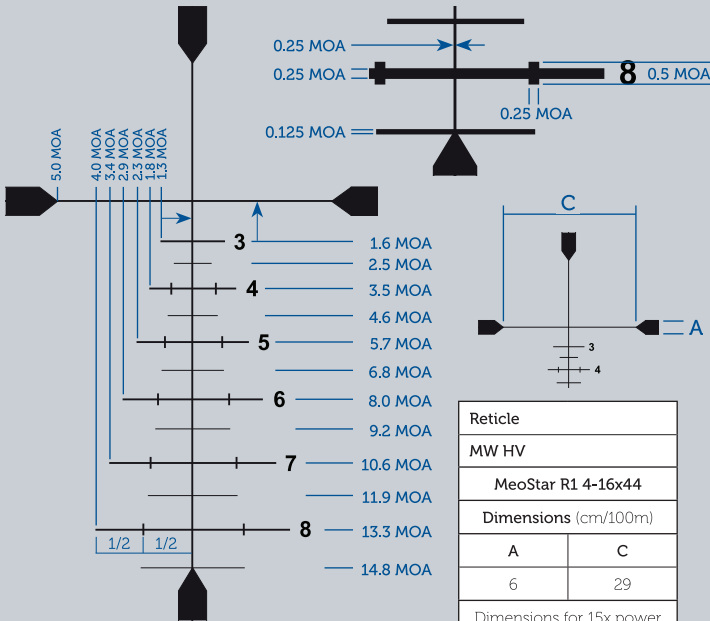
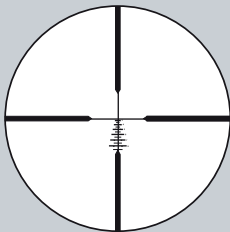

Reticle	
MW HV	
MeoStar R1 4-16x44	
Dimensions (cm/100m)	
A	C
6	29
Dimensions for 15x power	

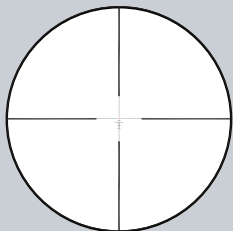

## BDC 2

Provides accurate holdovers for 200, 300, 350, 400, 450 and 500 yards out. @ maximum magnification (1 yard = 0.9144 m).

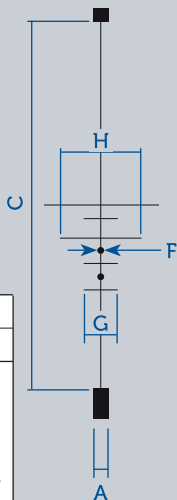
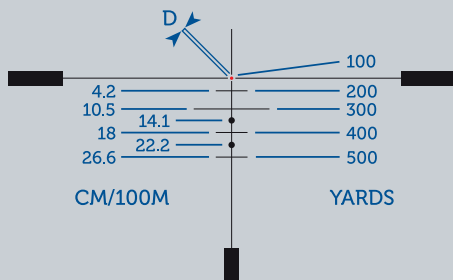

Reticle		Dimensions (cm/100m)					
BDC	Magn.	A	C	D	F	G	H
MeoPro 3,5-10x44 RD	7x	4	122	2	1.8	8.1	23.4
MeoStar R1 1,5-6x42 RD	5x			2,2			
MeoStar R1r 3-12x56 RD	7x			2			
MeoStar R2 1-6x24 RD	5x			2,8			
MeoStar R2 1,7-10x42 RD	7x			2			
MeoStar R2 2-12x50 RD	7x			2			
MeoStar R2 2,5-15x56 RD	7x			2			

Dimensions are valid for maximum power

### BDC 3

New type of reticle. Great for long range shooting with special wind correction.

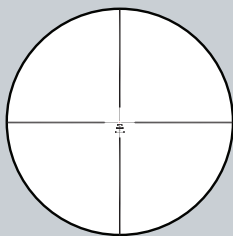
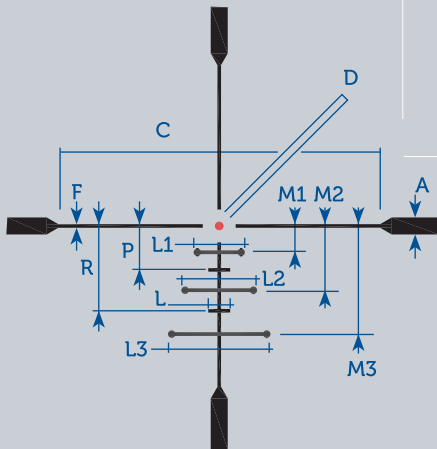

Reticle		Dimensions (cm/100m)												
BDC	Magn.	A	C	D	F	P	R	L	L1	L2	L3	M1	M1	M1
MeoPro 3,5-10x44 RD	7x	4,9	77	2	0,9	10,5	20,3	5,2	10,5	16,4	22,8	6,3	15,4	25,9
MeoStar R1 1,5-6x42 RD	5x			2,2										
MeoStar R1r 3-12x56 RD	7x			2										
MeoStar R2 1-6x24 RD	5x			2,8										
MeoStar R2 1,7-10x42 RD	7x			2										
MeoStar R2 2-12x50 RD	7x			2										
MeoStar R2 2,5-15x56 RD	7x			2										
Dimensions are valid for maximum power														



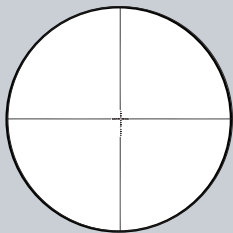

### MilDot 03

Reticle for easy determination of distance. Designed specifically according customer's needs. With extended bottom part. With illuminated center of reticle.

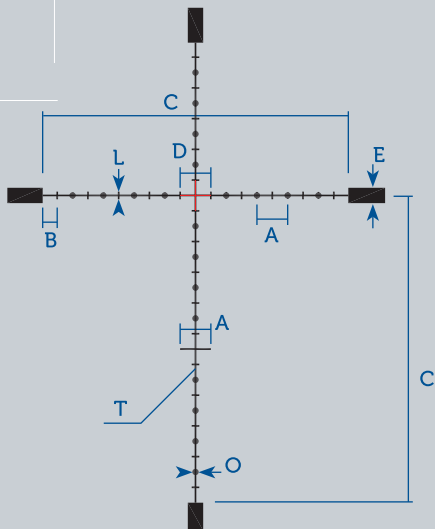

RETICLE	Dimensions (in mrad)							
MilDot 03	A	B	C	D	E	L	O	T
MeoTac 3-12x50 RD	1.0	0.5	10	1	0.5	0.25	0.20	0.05
Dimensions for all powers								

### MilDot 04

Reticle for easy determination of distance. Designed specifically according to customers needs. With extended bottom part. With illuminated of reticle.

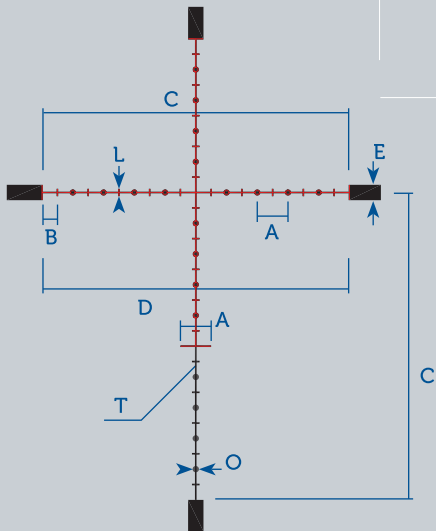
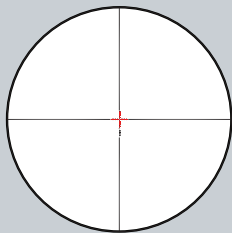

RETICLE	Dimensions (in mrad)							
	A	B	C	D	E	L	O	T
MilDot 03								
MeoTac 3-12x50 RD	1.0	0.5	10	10	0.5	0.25	0.20	0.05
Dimensions for all powers								

---

A BETTER  
VIEW  
OF THE  
WORLD

---



**Meopta-optika, s.r.o.**

Kabelikova 1

750 02 Prerov

Czech Republic

Tel. +420 581 241 111

[www.meoptasportsoptics.com](http://www.meoptasportsoptics.com)