



ELECTRO-OPTICS

JULIET™

JULIET3™ MAGNIFIER

OWNERS MANUAL

SIG SAUER®

TABLE OF CONTENTS

Introduction	3
Features	3
Contents	4
Product Identification	4
Installation	6
Operation	7
Specifications	8
Maintenance	10
SIG SAUER® Electro-Optics Infinite Guarantee™	11

This manual is available in the following languages: French, Spanish, German, Italian, Portuguese, Russian, Afrikaans, Swedish, and Norwegian. Please visit sigsauer.com for Owners Manual downloads.

INTRODUCTION

The SIG SAUER® JULIET3™ Magnifier provides users the ability to engage longer range targets with more accuracy. When mounted behind a Sig Sauer ROMEO Red Dot sight the quick flip away JULIET3 Magnifier allows the user to quickly change from close to long distance targets with a fast single handed operation. Lens covers protect your JULIET3 Magnifier from spent casings and other debris. Tested to MIL-SPEC standards, your JULIET3 Magnifier is built to never let you down.

FEATURES

(Vary depending upon model)

- Quick Release for easy removal when not in use
- PowerCam 90° Mount
- Rear flip back lens cover for added protection
- 2X lens filters to protect the objective lens of your magnifier
- IPX8 20 Meters for 1 hour

CONTENTS:

- JULIET3™ Magnifier
- JULIET Flip Away Mount
- 4 Screws (Gray Nylok patch) 1.41" Setting
- 1.53" Spacer Plate
- 4 Screws (Red Nylok patch) 1.53" Setting
- 1.63" Spacer Plate
- 4 Screws (Blue Nylok patch) 1.63" Setting
- Hex Tool
- 2 Thread In Lens Covers
- Flip Back

PRODUCT IDENTIFICATION

- A** Elevation Adjustment
- B** Windage Adjustment
- C** Diopter Adjustment Ring

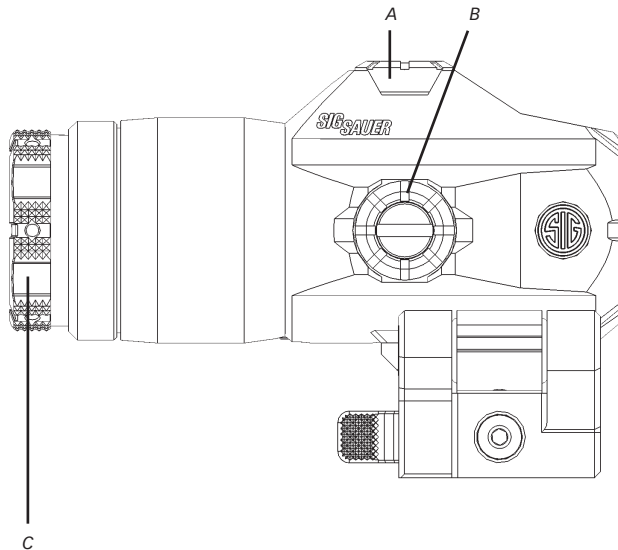

! WARNING

Before working on your JULIET3 Magnifier always ensure that the firearm is unloaded with the safety on.

INSTALLATION

The JULIET3 comes with two separate mounting plates that allow the user to mount the magnifier behind optics ranging from 1.41" to 1.63". If you need to raise the height of the JULIET3 you will need to remove your magnifier from the base and re-attach it with the correct riser plate and its corresponding length screws.

Once you have selected the correct height, mount the JULIET3 magnifier behind your red dot sight. Make sure that there is enough space between the two so that the magnifier can be rotated out of the way without making contact.

Adjust the torque of the adjustment screw on the opposite of the quick release lever so that the magnifier can be installed and removed without adjustment. If the adjustment screw is over tightened you will not be able to operate the quick release lever.

OPERATION

JULIET3 magnifiers are designed to operate behind red dot sights. When the magnifier is not in use flip it to the side to return to 1x power

ADJUSTMENTS

The JULIET3 should be adjusted to match your red dot sight. To do this, use the windage and elevation adjustment dials on the top and right side of the magnifier. You will want to adjust the magnifier so that the red dot is located in the center of the field of view. Adjusting the windage and elevation dials on your JULIET3 does not make changes to the POI of your firearm. Those adjustments will need to be made on your red dot sight.

The JULIET3 also has an adjustable diopter. To adjust the diopter rotate the diopter adjustment ring until the aiming feature is crisp and clear.

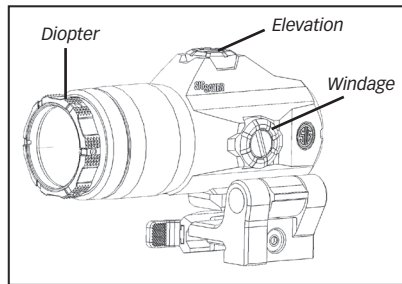

SPECIFICATIONS

JULIET3	
Magnification	3X
Field of View	8°
Objective Lens Clear Aperture	24mm
Exit Pupil	8mm
Eye Relief	65mm
Diopter Range	+/- 2
Adjustment Range	+/- 55 MOA
Waterproofing	20M, 1 hour

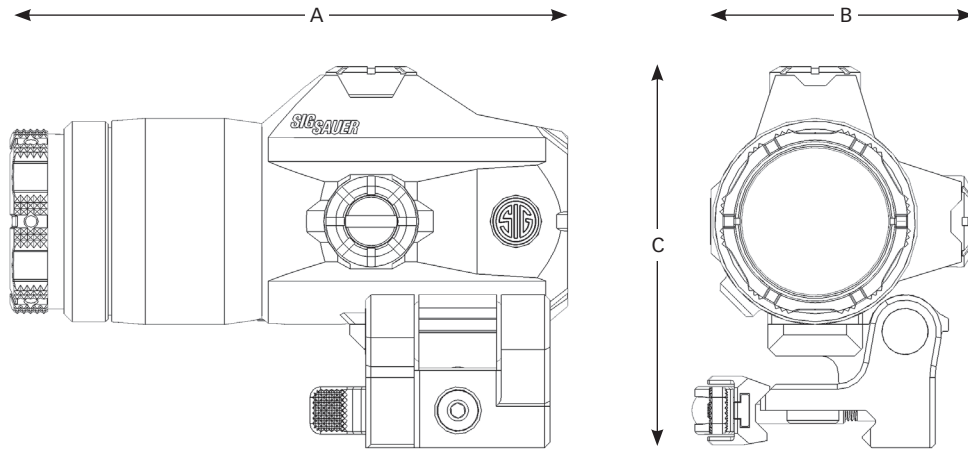

A – 4.23 in / 108 mm

B – 1.92 in / 71 mm

C – 2.80 in / 70 mm

MAINTENANCE

Cleaning- keep your lenses clear by using a soft cloth or lens pen. The best way to maintain image quality is by keeping your lenses clear of dirt and dust that cause scratches.

Always use your lens covers and flip backs to ensure that the sight optics remain scratch free.



SIG SAUER Electro-Optics Infinite Guarantee™

SIG SAUER has manufactured the most rugged, dependable high-performance firearms for over two centuries. Our heritage of design, engineering and precision-manufactured quality predates the existence of any other optics company worldwide. We understand the importance of quality in the line of fire, at the shooting range or on your next hunt. SIG SAUER Electro-Optics had to earn the right to wear that badge and the Infinite Guarantee has your back, forever. Period.

We will repair or replace your SIG SAUER product in the event it becomes damaged or defective, at no charge to you. If we cannot repair your product, we will replace it with a product in perfect working order of equal or better physical condition. It doesn't matter how it happened, whose fault it was, or where you purchased it.

SIG SAUER Infinite Guarantee™

- Unlimited Lifetime Guarantee
- Fully Transferable
- No Warranty Card Required
- No Receipt Required
- No Time Limit Applies
- No Charge

If you ever have a problem, no matter the cause, we promise to take care of you when it counts. Please note that our Infinite Guarantee does not provide coverage for intentional damage, misuse, cosmetic damage that does not affect the performance of the optic, loss, theft or unauthorized repair or modification. Excludes electronic components.



FOR PRODUCT SERVICE ON THIS MODEL, PLEASE CALL 603-610-3000

27100 SW Parkway Avenue, Wilsonville, Oregon 97070 USA