



# ATHLON

RIDICULOUSLY GOOD OPTICS

## 2020 PRODUCT CATALOG

Binoculars  
Riflescopes  
Spotting Scopes  
Rangefinders  
Red Dots  
Accessories

**SHARP, TIGHT  
AND PRICED  
JUST RIGHT!**

## CONTENT

### BINOCULARS

#### CRONUS UHD/ CRONUS UHD G2

15x56, 10x42

#### CRONUS UHD RANGEFINDING BINOCULARS

10x50

#### MIDAS UHD G2

12x50, 10x50, 10x42, 8x42, 10x25

#### ARGOS UHD & HD G2

12x50 HD, 10x50 HD, 10x42 HD, 8x42 HD,  
10x42 UHD, 8x42 UHD

#### NEOS HD G2

10x42, 8x42

### RIFLESCOPES

#### CRONUS BTR UHD

1-6x24, 4.5-29x56

#### ARES ETR UHD

4.5-30x56

#### ARES BTR GEN2 HD

2.5-15x50, 4.5-27x50

#### MIDAS TAC HD

4-16x44, 6-24x50, 5-25x56

#### MIDAS HMR HD

2.5-15x50

#### MIDAS BTR GEN2 HD

1-6x24, 4.5-27x50

#### HELOS BTR

1-4.5x24, 6-24x50, 8-34x56

#### ARGOS BTR GEN2

1-8x24, 6-24x50, 8-34x56, 10-40x56

#### TALOS BTR

1-4x24, 4-14x44

#### TALOS

3-12x40, 4-16x40, 6-24x50

#### NEOS

3-9x40, 4-12x40, 6-18x44

### SPOTTING SCOPE

#### CRONUS TACTICAL UHD

7-42x60

#### CRONUS UHD

20-60x86, 12-36x50

#### ARES UHD / ARES G2 UHD

20-60x85, 15-45x65

#### ARGOS HD

20-60x85

### RED DOTS

#### MIDAS Red Dot Sights

TSR1, TSR2, TSR3

#### MIDAS Prism Scopes

TSP3, TSP4

#### MIDAS Magnifiers

MG31, MG51

### LASER RANGEFINDERS

#### MIDAS 1200Y

#### MIDAS 1 MILE

### RIFLESCOPES

#### QUICK COMPARISON

### RETICLE SUBTENSIONS

### ACCESSORIES



First Focal Plane Riflescopes



Second Focal Plane Riflescopes

### KEY FEATURES LIST



**ABBE Prisms** maximize the light reflection to your eyes to give you the brightest and sharpest image.



**Advanced Fully Multi-Coated Lenses** deliver the highest level of light transmission for maximum brightness and true color across the entire light spectrum.



**Achromatic Lens System** gives you images with greater contrast, sharpness and color definition.



**Argon Purging** provides better waterproofing and thermal stability



**Bak-4 Glass Prisms** reflect more light to your eyes, resulting in a brighter and sharper image.



**E2ES System** is a field flattening system that produces sharper, clearer images all the way from one lens edge to another



**Extra-Low Dispersion Glass** gives you an image with little or no chromatic fringe for an ultimate clearest and sharpest image



**ESP Dielectric Coating** is a multi layer prism coating that reflects over 99% of the light to your eyes bringing you a clear, bright image with accurate colors



**Fully Multi-Coated Lenses** bring you better light transmission to bring optimum brightness and true color across the entire light spectrum.



**HD Glass** gives you better light transmission, brighter, and sharper image.



**Locking Turrets** allow you to pull up your turret to dial, and push down the turret to lock it in place.



**Long Eye Relief** is important for eyeglass wearers because longer eye relief allows them to still see the entire field of view.



**Magnesium Chassis** gives you the strength of a metal chassis while reducing the weight as much as 35%



**Multicoated** optics effectively reduce reflected light and increase the transmission of light giving you a brighter image than normal single coated lenses



**Phase Corrected Prisms** produce images that have better contrast, a higher resolution and excellent color reproduction.



**Precision Zero Stop System** allows you to return to your zero position and dial back to it with a sharp and precise stop right at your zero location



**Rubber Armor** provides durable and secure, non-slip soft texture grip for any weather condition.



**Nitrogen purging** dramatically reduces the moisture inside the tube and helps maintaining fog proof and waterproof.



**Waterproof** to protect the product in the harshest weather conditions or if accidentally submerged underwater.



**XPL Coating** gives you an extra protection on the exterior lenses from dirt, oil and scratches



CONTENT

athloptics.com

3



# YOUR PRIZE IN OPTICS

ATHLON is a proud US sports optics product company devoted to designing and delivering superior quality optics products and outdoor accessories at a competitive price to our consumers via our distribution and retail channels. Athlon has strong engineering design capabilities, strategic alliances with quality manufacturers and a streamlined fully integrated supply chain. These advantages enable us to bring the latest cutting edge technologies and cut out the extra layers of the traditional supply chain. With these advantages we are able to deliver goods and products to individual consumers' hands with great cost savings.

Our obsession with product quality and superior customer service for hunters, recreational shooters, and outdoor enthusiasts drives our business. The business model on which we founded Athlon allows us to deliver high quality optics at extremely competitive prices. Our goal from day one is to pass those savings to you, the outdoor enthusiast.

## LIFETIME WARRANTY

Your Athlon product is not only warranted to be free of defects in materials and workmanship for the lifetime of the product. Athlon will also repair or replace the product at no charge to you if you damage it through normal use. No receipt needed, no registration required. This is a commitment that Athlon Optics will be the best product you can buy for your money. This warranty does not cover damages caused by deliberate damage, misuse, theft or maintenance provided by someone other than the Athlon Authorized Service Department.



### BINOCULARS



**CRONUS G2 UHD**  
10 x 42 mm

**MIDAS G2 UHD**  
10 x 42 mm / 8 x 42 mm

**MIDAS G2 UHD**  
12 x 50 mm / 10 x 50 mm

**ARGOS G2 UHD**  
10 x 42 mm / 8 x 42 mm

**ARGOS G2 HD**  
10 x 42 mm / 8 x 42 mm

**ARGOS G2 HD**  
12 x 50 mm / 10 x 50 mm

**NEOS G2 HD**  
10 x 42 mm / 8 x 42 mm

### RIFLESCOPES



**ARES BTR GEN2 HD** 2.5-15x50 / 4.5-27x50 mm



**ARGOS BTR GEN2** 1-8x24 mm



**ARGOS BTR GEN2** 10-40x56 mm



**MIDAS TAC HD** 5-25x56 mm



**ARGOS BTR GEN2** 6-24x50 / 8-34x56 mm

### RED DOTS / PRISM SCOPES



**TSR1**



**TSR2**



**TSR3**



**TSP3**



**TSP4**

### SPOTTING SCOPES



**ARES G2 UHD - ANGLE** 15-45x65 mm



**ARGOS HD - ANGLE** 20-60x85 mm



**ARES G2 UHD - STRAIGHT** 15-45x65 mm



**ARGOS HD - STRAIGHT** 20-60x85 mm

### PRECISION RINGS



NEW PRODUCTS FOR 2020

athlonoptics.com



# CRONUS UHD/ CRONUS UHD G2 BINOCULARS

Designed for serious glassing, with exceptional edge to edge clarity, sharp detail enhancement, ultra-clear brightness and true color representation. We designed these binoculars with our revolutionary E2ES lens system that gives you a flat field of view. We included ED Glass that results in clearer and sharper image. Dielectric coating reflects 99% of the light through the prism assembly. Our state of the art light weight Magnesium chassis helps lighten your load all the while maintaining the ruggedness to withstand the scrapes & bumps of constant use. These Cronus binoculars can take a hit!



10 x 42 mm G2



15 x 56 mm

### PRODUCT SPECIFICATION

MODEL	OBJECTIVE LENS DIAMETER	EYE RELIEF	FIELD OF VIEW ANGULAR	FOV @1000 YARDS	CLOSE FOCUS	INTERPUPILLARY DISTANCE	WEIGHT	HEIGHT X WIDTH
15x56 mm	56 mm	18.5 mm	4.5°	235 ft	13.1 ft	59-74 mm	45.2 oz	8.7x6.2"
10x42 mm	42 mm	19.3 mm	6.5°	338 ft	6.6 ft	56-73 mm	27.8 oz	6.3x5.1"

### KEY FEATURES



### OTHER FEATURES

Phase Coated, BaK4 Prisms, Advanced Fully Multi-Coated, Argon Purged, Magnesium Chassis, Locking Diopter, Long Eye Relief, Close Focus, Twist Up Eye-Cups, Waterproof, Tripod Adaptable



# CRONUS UHD RANGEFINDING BINOCULARS

With ranging capabilities of 5 yards to 1000 yards on a deer and out to 2600 yards on a reflective target, these Ranging Binoculars are perfect for any hunting or long range situations. We designed these binoculars with our revolutionary E2ES lens system that gives you a flat field of view. We included ED Glass that results in clearer and sharper image as well as an illuminated ranging display.



10 x 50 mm



Display Preview

### PRODUCT SPECIFICATION

MODEL	OBJECTIVE LENS DIAMETER	EYE RELIEF	FIELD OF VIEW ANGULAR	FOV @1000 YARDS	CLOSE FOCUS	INTERPUPILLARY DISTANCE	WEIGHT	HEIGHT X WIDTH
10x50 mm	50 mm	17.0 mm	6.2°	325 ft	9.8 ft	58-76 mm	38.0 oz	6.7x5.4"

### RANGEFINDING SPECIFICATION

RANGING REFLECTIVE	RANGING DEER	ACCURACY	POWER SUPPLY	DISPLAY
2600 Y	1000 Y	+ / -1 Y	CR2-3V	Red Illuminated OLED Display Screen

### KEY FEATURES



### OTHER FEATURES

Dual Units of Measurement of Distance (Y/M), Angle Compensation Mode, Argon Purged, Waterproof,





# MIDAS UHD G2 BINOCULARS

Midas was known to have a golden touch. He must have laid his hands on these binoculars since they set the gold standard for this class of binoculars. The rugged benchmark for all-weather brightness and clarity, these Midas roof-prism binoculars are light and slim thanks to the magnesium designed chassis. Together with ED Glass lenses, Advanced Fully Multi-Coated optics, high-quality Bak-4 prisms with our ESP Dielectric coating plus phase coating, these Midas binoculars gather maximum light and produce brilliant color fidelity.



## PRODUCT SPECIFICATION

MODEL	OBJECTIVE LENS DIAMETER	EYE RELIEF	FIELD OF VIEW ANGULAR	FOV @1000 YARDS	CLOSE FOCUS	INTERPUPILLARY DISTANCE	WEIGHT	HEIGHT X WIDTH
12x50 mm	50 mm	15.0 mm	5.4°	281 ft	11.5 ft	59-74 mm	32 oz	6.7x5.4"
10x50 mm	50 mm	16.9 mm	6.5°	341 ft	9.8 ft	59-74 mm	32 oz	6.7x5.4"
10x42 mm	42 mm	15.2 mm	6.5°	341 ft	8.2 ft	57-74 mm	23.3 oz	5.7x5.2"
8x42 mm	42 mm	17.2 mm	8.1°	426 ft	6.5 ft	57-74 mm	23.3 oz	5.7x5.2"
10x25 mm	25 mm	15.5 mm	5.4°	285 ft	5.2 ft	56-74 mm	8.3 oz	4.3x4.1"

## KEY FEATURES



## OTHER FEATURES

Phase Coated, Magnesium Chassis, Bak-4 Glass Prisms, Advanced Fully Multi-Coated Lenses, Long Eye Relief, Close Focus, Twist Up Eye-Cups, Waterproof, Tripod Adaptable





# ARGOS HD & UHD G2 BINOCULARS

Argos binoculars come with superior quality and bright lenses that are Advanced Fully Multi-Coated for sharp contrast, true color and excellent light gathering. They also have Bak-4 prism glass that have our new ESP Dielectric coating and phase correction for color fidelity and sharpness. They're Argon gas purged for waterproof & non-fogging. The extra durable magnesium chassis takes weight off your neck but at the same time stands up to the demands of hunting in any conditions.



### PRODUCT SPECIFICATION

MODEL	OBJECTIVE LENS DIAMETER	EYE RELIEF	FIELD OF VIEW ANGULAR	FOV @1000 YARDS	CLOSE FOCUS	INTERPUPILLARY DISTANCE	WEIGHT	HEIGHT X WIDTH
HD 12x50 mm	50 mm	16.0 mm	4.9 °	257 ft	13 ft	56-76 mm	31.5 oz	6.8x5.6"
HD 10x50 mm	50 mm	17.0 mm	5.8 °	304 ft	13 ft	56-76 mm	31.5 oz	6.8x5.6"
HD 10x42 mm	42 mm	16.1 mm	6.1 °	319 ft	13 ft	56-76 mm	25.5 oz	5.7x5.3"
HD 8x42 mm	42 mm	17.3 mm	7.1 °	371 ft	13 ft	56-76 mm	25.5 oz	5.7x5.3"
UHD 10x42 mm	42 mm	16.1 mm	6.1 °	319 ft	13 ft	56-76 mm	25.5 oz	5.7x5.3"
UHD 8x42 mm	42 mm	17.3 mm	7.1 °	371 ft	13 ft	56-76 mm	25.5 oz	5.7x5.3"

### KEY FEATURES



### OTHER FEATURES

Bak-4 Glass Prisms, Advanced Fully Multi-Coated Lenses, Long Eye Relief, Close Focus, Twist Up Eye-Cups, Waterproof, Tripod Adaptable, Argon Purged



# NEOS HD G2 BINOCULARS

The Neos series of binoculars are built tough, with a composite chassis that's O-ring sealed and nitrogen purged for 100% waterproof/fog-proof so if you simply run into foul weather along the way or should you take a spill in a stream, or for that matter take a spill overboard, your Neos bins are ready for it. Rubber armoring gives you a firm grip in slippery situations.



### PRODUCT SPECIFICATION

MODEL	OBJECTIVE LENS DIAMETER	EYE RELIEF	FIELD OF VIEW ANGULAR	FOV @1000 YARDS	CLOSE FOCUS	INTERPUPILLARY DISTANCE	WEIGHT	HEIGHT X WIDTH
10x42 mm	42 mm	14.1 mm	5.9 °	309 ft	13.1 ft	56-72 mm	21 oz	5.9x4.9"
8x42 mm	42 mm	17 mm	7.0 °	367 ft	13.1 ft	56-72 mm	21 oz	5.9x4.9"

### KEY FEATURES



### OTHER FEATURES

Long Eye Relief, Close Focus, Twist Up Eye-Cups, Tripod Adaptable, Nitrogen Purged





# CRONUS BTR UHD RIFLESOPES

Whether you want to engage in precision long-range shooting and tactical applications, or extreme long range hunting adventures, the new Cronus BTR scope is just what the doctor ordered. Loaded with features this scope will not let you down when you need it most. This First Focal Plane scope features ED glass, Advanced Fully Multi-Coated lenses, Argon purged, a true zero stop and much more. When you need the best, the Cronus BTR is the answer!



1-6x24 mm



4.5-29x56 mm



4.5-29x56 mm

## AVAILABLE RETICLES

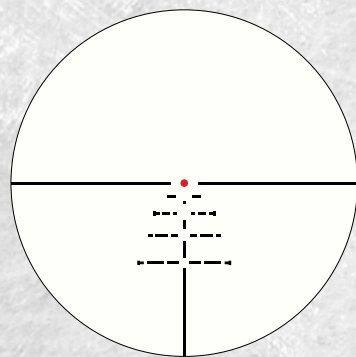

ATSR2 SFP IR MOA

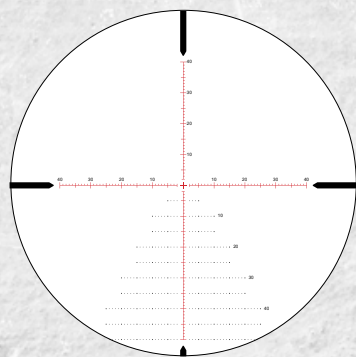

APLR5 FFP IR MOA

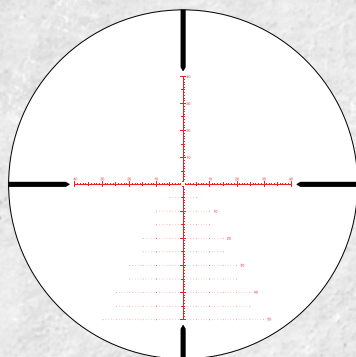

APLR5 FFP IR MOA

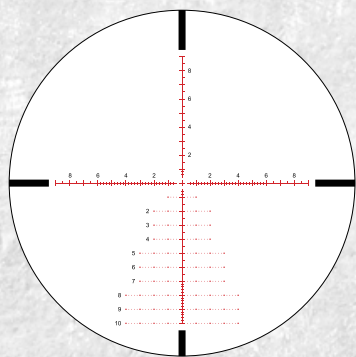

APRS1 FFP IR MIL

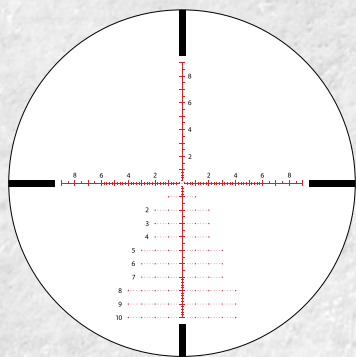

APRS1 FFP IR MIL

## PRODUCT SPECIFICATION

POWER X OBJECTIVE LENS	TURRET STYLE	TUBE SIZE	AVAILABLE RETICLES	SURFACE FINISH	EYE RELIEF	FOV @100 YARDS	WEIGHT	CLICK VALUE	ADJ. RANGE PER ROTATION	TOTAL ELEV. ADJ.	TOTAL WINDAGE ADJ.	PARALLAX ADJ.	PURGING MATERIAL	DIMENSIONS							
														L1	L2	L3	L4	L5	L6	D1	D2
1-6x24 SFP	EXPOSED	30 mm	ATSR2 SFP IR MOA	MATTE	3.6-4.0"	106.9-17.7 ft	18.8 oz	0.5 MOA	32 MOA	120 MOA	120 MOA	FIXED 100 yds	ARGON	10.4" /	6.9"	3.5"	2"	3.6"	1.7"	1.2"	
4.5-29x56 FFP	EXPOSED	34 mm	APLR5 FFP IR MOA	MATTE / *BROWN	3.6-3.8"	24.8-3.83 ft	35.8 oz	0.25 MOA	25 MOA	110 MOA	64 MOA	SIDE FOCUS 25yds - ∞	ARGON	14.4"	3.9"	6.3"	4.2"	2.6"	2"	1.8"	2.6"
			APRS1 FFP IR MIL					0.1 MIL	10 MIL	32 MIL	18 MIL										
			APRS1 FFP IR MIL					0.1 MIL	10 MIL	32 MIL	18 MIL										

\*Brown available in select models

## KEY FEATURES



## OTHER FEATURES

High Precision Erector System , Aircraft Grade Aluminum Tube , Side Parallax Adjustment, Illuminated Glass Reticles, Exposed Turrets

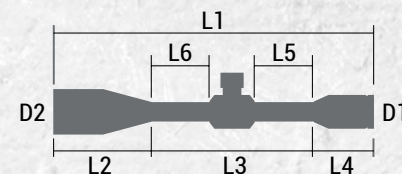



# ARES ETR UHD RIFLESCOPIES

Just when you thought we couldn't improve the Ares BTR, well we did! The Ares ETR First Focal Plane scope is loaded with features that will allow you to take your long range shooting to another level. Featuring a completely revamped turret system, the Ares ETR has a locking Windage turret along with a true zero stop on the elevation turret to make sure your turrets and shots are right on every time. Extra Low dispersion lenses allow for the sharpest and best color image possible. Constructed with an 34mm tube, this riflescope can withstand even the harshest of elements.



4.5-30x56 mm



4.5-30x56 mm

## AVAILABLE RETICLES

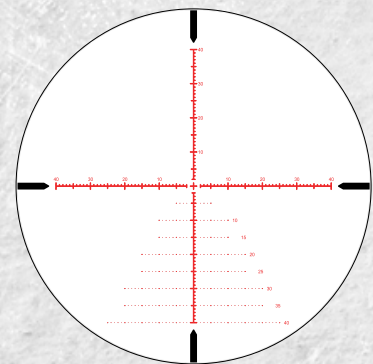

APLR2 FFP IR MOA

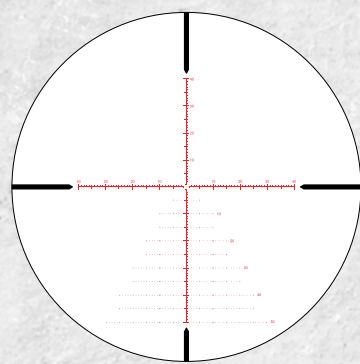

APLR5 FFP IR MOA

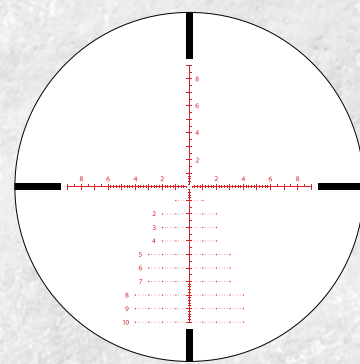

APRS1 FFP IR MIL

## PRODUCT SPECIFICATION

POWER X OBJECTIVE LENS	TURRET STYLE	TUBE SIZE	AVAILABLE RETICLES	SURFACE FINISH	EYE RELIEF	FOV @100 YARDS	WEIGHT	CLICK VALUE	ADJ. RANGE PER ROTATION	TOTAL ELEV. ADJ.	TOTAL WINDAGE ADJ.	PARALLAX ADJ.	PURGING MATERIAL	DIMENSIONS							
														L1	L2	L3	L4	L5	L6	D1	D2
4.5-30x56 FFP	EXPOSED/LOCKING	34 mm	APLR2 FFP IR MOA APLR5 FFP IR MOA APRS1 FFP IR MIL	MATTE / *BROWN	3.9"	24.5-3.75 ft	36.5 oz	0.25 MOA 0.1 MIL	25 MOA 10 MIL	110 MOA 32 MIL	110 MOA 32 MIL	SIDE FOCUS 25yds - ∞	ARGON	15.3"	5.0"	6.6"	3.7"	2.7"	2.3"	1.83"	2.5"

\* Locking feature on Windage Turret only

\*Brown available in select models

## KEY FEATURES



## OTHER FEATURES

High Precision Erector System , Aircraft Grade Aluminum Tube , Side Parallax Adjustment, Illuminated Glass Reticles, Exposed Turrets

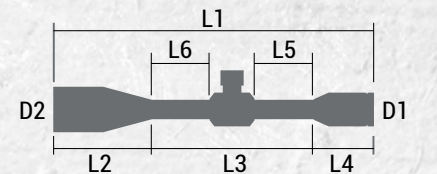





# ARES BTR GEN2 HD RIFLESCOPES

Built off the success of the 1st generation Ares BTR, the GEN2 is still a top-tier riflescope, without the price tag. The Ares BTR GEN2 acquires a new stainless steel turret design, just like the Midas TAC and Ares ETR lines. The new turret design features sharper, more tactile clicks. Featuring HD glass, a new optical system provides an even brighter and clearer image throughout the magnification range. A one-piece, precision machined aircraft grade aluminum scope body, precision zero stop, and impeccable tracking will deliver precise, accurate results in any field.



**NEW**  
2.5-15x50 mm



**NEW**  
4.5-27x50 mm

### AVAILABLE RETICLES

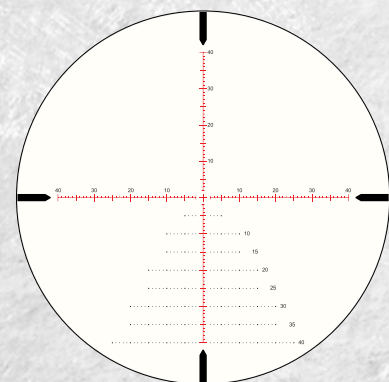

APLR3 FFP IR MOA

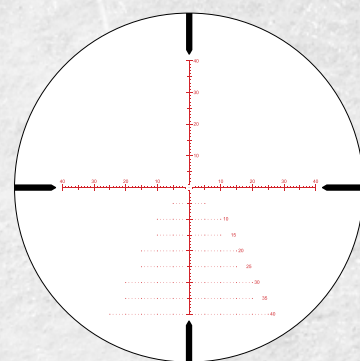

APLR4 FFP IR MOA

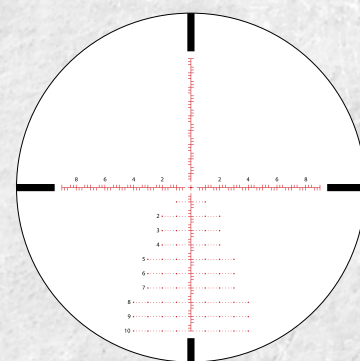

APLR3 FFP IR MIL

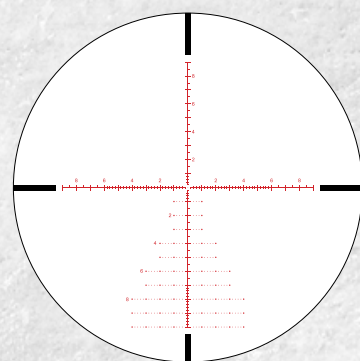

APRS5 FFP IR MIL

### PRODUCT SPECIFICATION

POWER X OBJECTIVE LENS	TURRET STYLE	TUBE SIZE	AVAILABLE RETICLES	SURFACE FINISH	EYE RELIEF	FOV @100 YARDS	WEIGHT	CLICK VALUE	ADJ. RANGE PER ROTATION	TOTAL ELEV. ADJ.	TOTAL WINDAGE ADJ.	PARALLAX ADJ.	PURGING MATERIAL	DIMENSIONS							
														L1	L2	L3	L4	L5	L6	D1	D2
2.5-15x50 FFP	EXPOSED	30 mm	APLR3 FFP IR MOA	MATTE	3.9"	41.8-6.8 ft	27.3 oz	0.25 MOA	25 MOA	100 MOA	100 MOA	SIDE FOCUS 10yds - ∞	ARGON	13.8"	4.7"	5.5"	3.6"	1.8"	2.2"	1.78"	2.25"
			APLR3 FFP IR MIL					0.1 MIL	10 MIL	29 MIL	29 MIL										
4.5-27x50 FFP	EXPOSED	30 mm	APLR3 FFP IR MOA	MATTE	3.9"	22.7-3.8 ft	27.3 oz	0.25 MOA	25 MOA	80 MOA	80 MOA	SIDE FOCUS 25yds - ∞	ARGON	13.8"	4.7"	5.5"	3.6"	1.8"	2.2"	1.78"	2.25"
			APLR4 FFP IR MOA					0.1 MIL	10 MIL	24 MIL	24 MIL										
			APLR3 FFP IR MIL																		
			APRS5 FFP IR MIL																		

### KEY FEATURES



### OTHER FEATURES

High Precision Erector System, Aircraft Grade Aluminum Tube, Side Parallax Adjustment, Illuminated Glass Reticles, Exposed Turrets

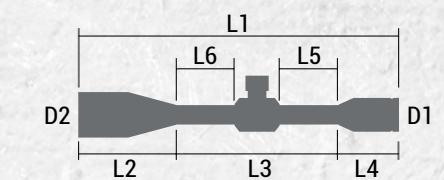



# MIDAS TAC HD RIFlescOPES



Here at Athlon Optics we have listened to your feedback and suggestions and developed the Midas TAC. Loaded with features including HD Glass, Advanced Fully Multi-Coated lenses to enhance target appearance at all distances, a hard Zero Stop for repeatability and Capped Windage Turret to prevent accidental adjustments. This is not just another option, but the solution!



4-16x44 mm



5-25x56 mm (34 mm tube)



6-24x50 mm

NEW

## PRODUCT SPECIFICATION

POWER X OBJECTIVE LENS	TURRET STYLE	TUBE SIZE	AVAILABLE RETICLES	SURFACE FINISH	EYE RELIEF	FOV @100 YARDS	WEIGHT	CLICK VALUE	ADJ. RANGE PER ROTATION	TOTAL ELEV. ADJ.	TOTAL WINDAGE ADJ.	PARALLAX ADJ.	PURGING MATERIAL	DIMENSIONS								
														L1	L2	L3	L4	L5	L6	D1	D2	
4-16x44 FFP	*EXPOSED/ CAPPED	30 mm	APRS2 FFP MIL	MATTE	3.7"	27.7-7 ft	23.8 oz	0.1 MIL	10 MIL	30 MIL	15 MIL	SIDE FOCUS 10yds - ∞	ARGON	14.2"	4.3"	6.3"	3.6"	2.5"	2.6"	1.71"	2.0"	
5-25x56 FFP	*EXPOSED/ CAPPED	34 mm	APLR4 FFP MOA	MATTE	3.7"	22.1-4.5 ft	30.0 oz	0.25 MOA	25 MOA	110 MOA	110 MOA	SIDE FOCUS 25yds - ∞	ARGON	15.1"	4.8"	6.6"	3.7"	2.7"	2.36"	1.83"	2.5"	
			APRS3 FFP MIL																			
6-24x50 FFP	*EXPOSED/ CAPPED	30 mm	APLR4 FFP MOA	MATTE	3.7"	17.8-4.6 ft	26.3 oz	0.25 MOA	25 MOA	85 MOA	50 MOA	SIDE FOCUS 10yds - ∞	ARGON	14.6"	4.5"	6.3"	3.8"	2.2"	2.6"	1.71"	2.25"	
			APRS2 FFP MIL																			
			APRS3 FFP MIL					0.1 MIL	10 MIL	25 MIL	15 MIL											

\* EXPOSED - Elevation Turret / CAPPED - Windage Turret

## KEY FEATURES



## OTHER FEATURES

Aircraft Grade Aluminum, Side Parallax Adjustment, Non-Illuminated Glass Reticles

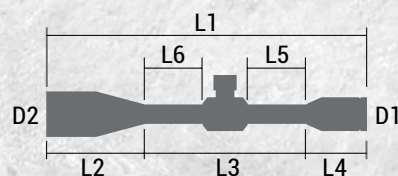

## AVAILABLE RETICLES

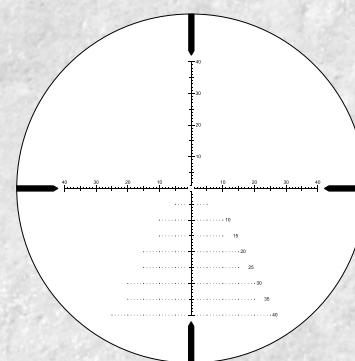

APLR4 FFP MOA

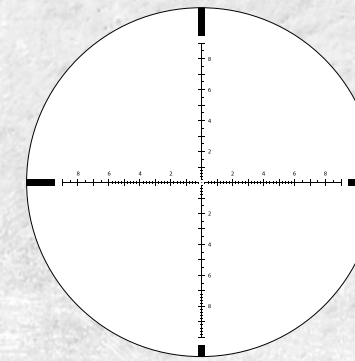

APRS2 FFP MIL

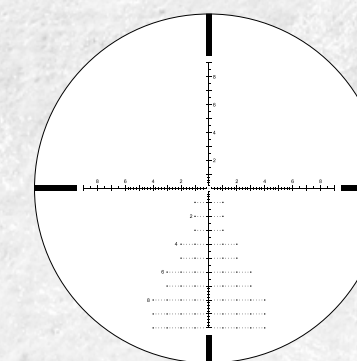

APRS3 FFP MIL





# MIDAS HMR HD RIFLESCOPIES

Attention all hunters, attention all hunters! We have great news for you! We would like to introduce the Midas HMR Second Focal Plane rifle scope line made by hunters, for hunters.

Featuring HD Glass and advanced fully multicoated optics deliver crisp bright images for taking a shot, short or long. This one piece tube, precision-machined from aircraft grade aluminum will deliver precise, accurate results all day long. Both elevation and windage turrets are capped to make sure nothing gets bumped after you set your zero. You can always count on it to deliver the final punch.



2.5-15x50 mm

## AVAILABLE RETICLES

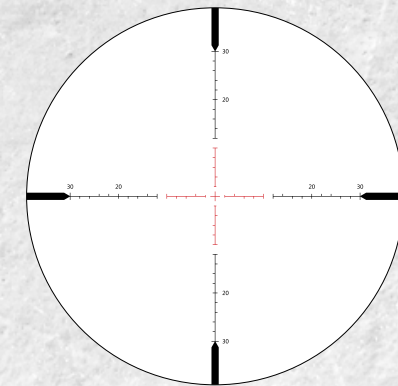

AHMR SFP IR MOA

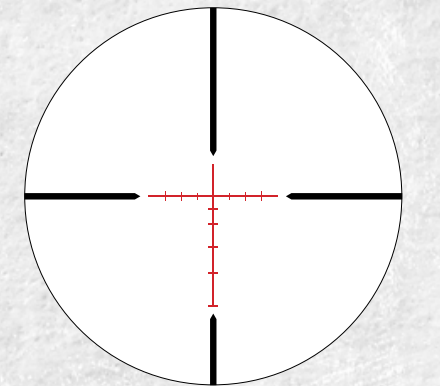

BDC 600A

## PRODUCT SPECIFICATION

POWER X OBJECTIVE LENS	TURRET STYLE	TUBE SIZE	AVAILABLE RETICLES	SURFACE FINISH	EYE RELIEF	FOV @100 YARDS	WEIGHT	CLICK VALUE	ADJ. RANGE PER ROTATION	TOTAL ELEV. ADJ.	TOTAL WINDAGE ADJ.	PARALLAX ADJ.	PURGING MATERIAL	DIMENSIONS							
														L1	L2	L3	L4	L5	L6	D1	D2
2.5-15x50 SFP	CAPPED	30 mm	AHMR SFP IR MOA BDC 600A	MATTE	3.9"	41.8-6.8 ft	26 oz	0.25 MOA	15 MOA	60 MOA	60 MOA	SIDE FOCUS 10yds - ∞	ARGON	13.8"	4.8"	5.5"	3.5"	2.0"	2.4"	1.8"	2.3"

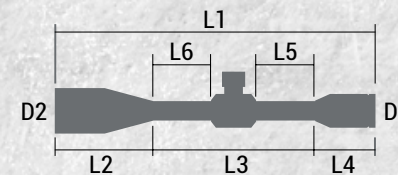

## KEY FEATURES



## OTHER FEATURES

Aircraft Grade Aluminum Tube, Side Parallax Adjustment, Illuminated Glass Reticles





# MIDAS BTR GEN2 HD RIFLESOPES

This Second Focal Plane variable power scope will be the perfect optic for you regardless of whether or not you are shooting small targets at a few hundred yards, shooting 3-gun matches, or hunting big game anywhere in the world, this will be the perfect option for you.

With new and improved tactile turrets, a true zero stop, and updated reticle designs; you won't find a better option on the market for any of your applications. HD glass equipped with our Advanced Fully Multi-Coated lenses so you'll have the brightest, clearest image possible in any situation. The innovative XPL coating protects your lenses from oil, dirt and smudges.



1-6x24 mm



4.5-27x50 mm

## AVAILABLE RETICLES

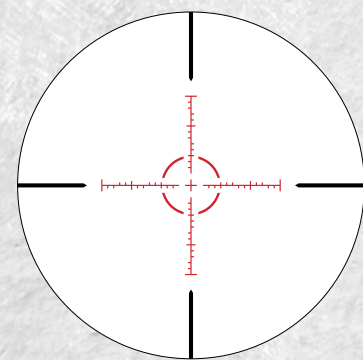

ATSR16 SFP IR MOA

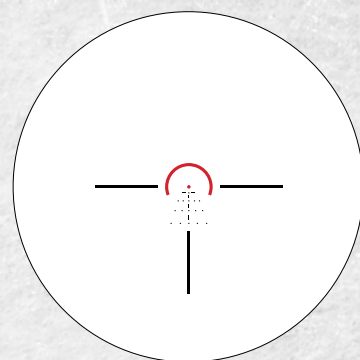

ATSR4 SFP IR MOA

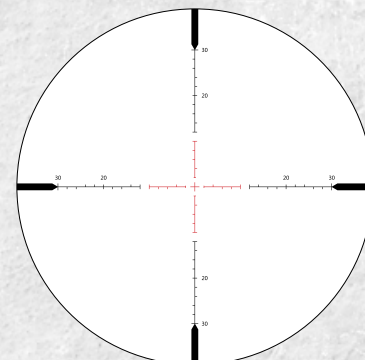

AHMR SFP IR MOA

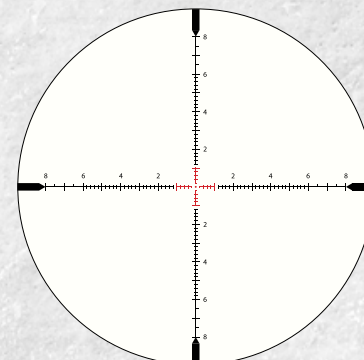

APRS4 SFP IR MIL

## PRODUCT SPECIFICATION

POWER X OBJECTIVE LENS	TURRET STYLE	TUBE SIZE	AVAILABLE RETICLES	SURFACE FINISH	EYE RELIEF	FOV @100 YARDS	WEIGHT	CLICK VALUE	ADJ. RANGE PER ROTATION	TOTAL ELEV. ADJ.	TOTAL WINDAGE ADJ.	PARALLAX ADJ.	PURGING MATERIAL	DIMENSIONS							
														L1	L2	L3	L4	L5	L6	D1	D2
1-6x24 SFP	CAPPED	30 mm	ATSR16 SFP IR MOA ATSR4 SFP IR MOA	MATTE	3.8"	108-17.6 ft	18.1 oz	0.5 MOA	30 MOA	150 MOA	150 MOA	FIXED 100 yds	ARGON	10.6" / 7"	3.7"	2.3"	3.5"	1.7"	1.2"		
4.5-27x50 SFP	EXPOSED	30 mm	AHMR SFP IR MOA APRS4 SFP IR MIL	MATTE	3.9"	22.7-3.6 ft	26.0 oz	0.25 MOA 0.1 MIL	25 MOA 10 MIL	85 MOA 25 MIL	85 MOA 25 MIL	SIDE FOCUS 30 yds - ∞	ARGON	13.9"	4.9"	5.5"	3.5"	2"	2.4"	1.8"	2.3"

## KEY FEATURES



## OTHER FEATURES

Aircraft Grade Aluminum Tube, High Precision Erector System, Side Parallax Adjustment, Illuminated Glass Reticles, Capped/Exposed Turrets

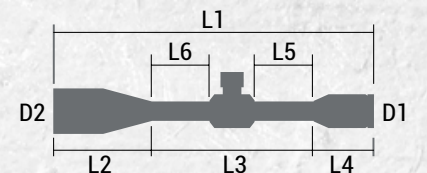



# HELOS BTR RIFLESOPES

Locking turrets aren't just for hunting. The Helos BTR has something for long range shooters and service rifle competitors as well! A one piece aircraft grade aluminum tube housing Advanced Fully Multi-Coated lenses gives you a sharp, robust riflescope. The long range models have crisp locking turrets. The 1-4.5x24 service rifle scope has a 1 revolution limiter and zero stop, ensuring you never lose track of your initial zero.



1-4.5x24 mm



6-24x50 mm



8-34x56 mm

\* Precision Zero Stop System - only 1-4.5x24

## AVAILABLE RETICLES

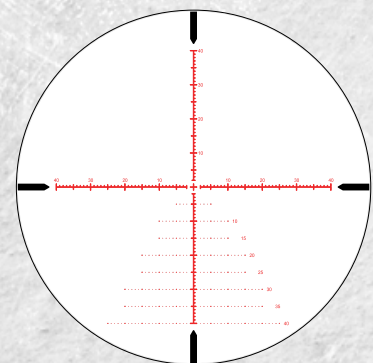

APLR2 FFP IR MOA

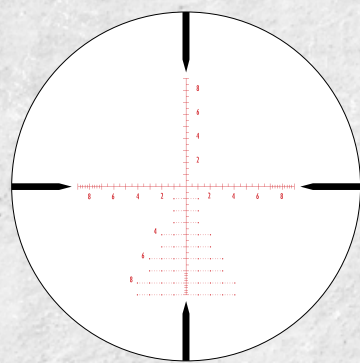

APMR FFP IR MIL

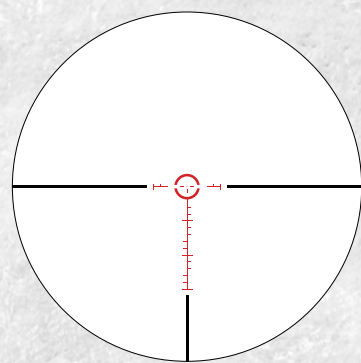

ATSR3 SFP IR MOA

## PRODUCT SPECIFICATION

POWER X OBJECTIVE LENS	TURRET STYLE	TUBE SIZE	AVAILABLE RETICLES	SURFACE FINISH	EYE RELIEF	FOV @100 YARDS	WEIGHT	CLICK VALUE	ADJ. RANGE PER ROTATION	TOTAL ELEV. ADJ.	TOTAL WINDAGE ADJ.	PARALLAX ADJ.	PURGING MATERIAL	DIMENSIONS							
														L1	L2	L3	L4	L5	L6	D1	D2
1-4.5x24 SFP	EXPOSED	30 mm	ATSR3 SFP IR MOA	MATTE	3.2"	100-22 ft	22.9 oz	0.25 MOA	23 MOA	80 MOA	80 MOA	SIDE FOCUS 10yds - ∞	ARGON	9.5"	/	6"	3.5"	1.9"	2.1"	1.6"	1.2"
6-24x50 FFP	EXPOSED	30 mm	APLR2 FFP IR MOA APMR FFP IR MIL	MATTE	3.3"	16.7-4.5 ft	29.7 oz	0.25 MOA 0.1 MIL	15 MOA 6 MIL	60 MOA 18 MIL	60 MOA 18 MIL	SIDE FOCUS 10yds - ∞	ARGON	14.0"	4.1"	6.2"	3.7"	2.0"	2.1"	1.8"	2.2"
8-34x56 FFP	EXPOSED	30 mm	APLR2 FFP IR MOA APMR FFP IR MIL	MATTE	3.3"	12.5-3 ft	32.3 oz	0.25 MOA 0.1 MIL	15 MOA 6 MIL	45 MOA 13 MIL	45 MOA 13 MIL	SIDE FOCUS 15yds - ∞	ARGON	15.5"	4.9"	6.9"	3.7"	2.0"	2.9"	1.8"	2.5"

## KEY FEATURES



## OTHER FEATURES

First Focal Plane Reticle, High Precision Erector System, Side Parallax Adjustment, 30 mm Tubes, Illuminated Glass Reticles, Exposed Turrets  
\*Zero Stop only on 1-4.5x24

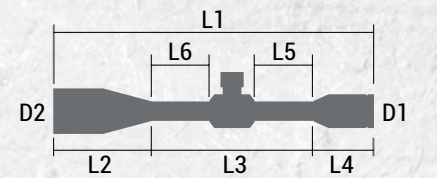



# ARGOS BTR GEN2 RIFLESCOPES

A precision long range optic with features normally found on high-end riflescopes. The Argos BTR GEN2 is designed for precision shooting on a budget. Advanced Fully Multi-Coated Optics deliver a clear bright image in low-light environments. The GEN2 now features Athlon's Precision Zero Stop System, for a quick-hard stop when returning to zero. It also features turrets with sharper, more tactile clicks.



\*Capped Turrets 1-8x24 mm



6-24x50 mm



8-34x56 mm



10-40x56 mm

### KEY FEATURES



### OTHER FEATURES

Zero Stop (6-24x50, 8-34x56, 10-40x56), High Precision Erector System, Side Parallax Adjustment, Illuminated Glass Reticles, Waterproof

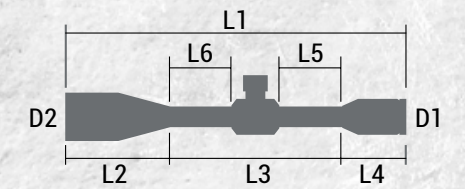

### AVAILABLE RETICLES

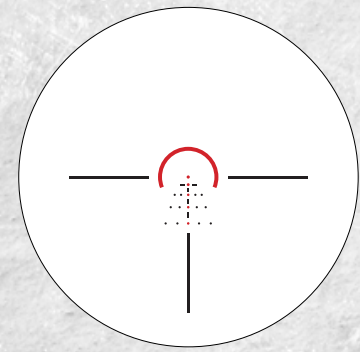

ATSR5 SFP IR MOA

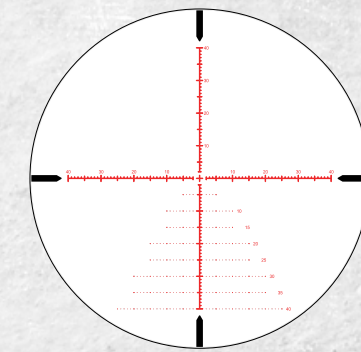

APLR2 FFP IR MOA

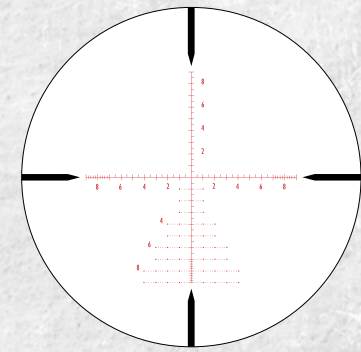

APMR FFP IR MIL

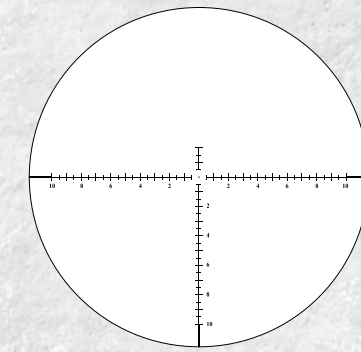

BLR SFP MOA

### PRODUCT SPECIFICATION

POWER X OBJECTIVE LENS	TURRET STYLE	TUBE SIZE	AVAILABLE RETICLES	SURFACE FINISH	EYE RELIEF	FOV @100 YARDS	WEIGHT	CLICK VALUE	ADJ. RANGE PER ROTATION	TOTAL ELEV. ADJ.	TOTAL WINDAGE ADJ.	PARALLAX ADJ.	PURGING MATERIAL	DIMENSIONS							
														L1	L2	L3	L4	L5	L6	D1	D2
1-8x24 SFP	CAPPED	30 mm	ATSR5 SFP IR MOA	MATTE	3.5"	112-27 ft	16.1 oz	0.5 MOA	44 MOA	120 MOA	120 MOA	FIXED 100 yds	ARGON	9.8"	/	6.2"	3.6"	2.3"	2.4"	1.8"	1.2"
6-24x50 FFP	EXPOSED	30 mm	APLR2 FFP IR MOA	MATTE	3.3"	16.7-4.5 ft	30.3 oz	0.25 MOA	12 MOA	60 MOA	60 MOA	SIDE FOCUS 10yds - ∞	ARGON	14.1"	4.2"	6.2"	3.7"	2"	2.1"	1.8"	2.2"
			APMR FFP IR MIL			0.1 MIL		5 MIL	18 MIL	18 MIL											
8-34x56 FFP	EXPOSED	30 mm	APLR2 FFP IR MOA	MATTE	3.3"	12.5-3 ft	32 oz	0.25 MOA	12 MOA	45 MOA	45 MOA	SIDE FOCUS 15yds - ∞	ARGON	15.5"	4.9"	6.9"	3.7"	2"	2.9"	1.8"	2.5"
			APMR FFP IR MIL			0.1 MIL		5 MIL	13 MIL	13 MIL											
10-40x56 SFP	EXPOSED	30 mm	BLR SFP MOA	MATTE	3"	12.6-3.1 ft	31.8 oz	0.125 MOA	6 MOA	45 MOA	45 MOA	SIDE FOCUS 15yds - ∞	ARGON	16.3"	6"	6.8"	3.5"	1.5"	3.3"	1.8"	2.5"





# TALOS BTR RIFLESCOPIES

The Talos BTR is available in two configurations; 4-14x44 - First Focal Plane or 1-4x24 Second Focal Plane. Both of these scopes are great entry level scopes for competitive and tactical shooting. Featuring Multi-Coated lenses for clarity and brightness in low light conditions as well as being waterproof, this family is ready to get you started shooting.



1-4x24 mm



4-14x44 mm

## AVAILABLE RETICLES

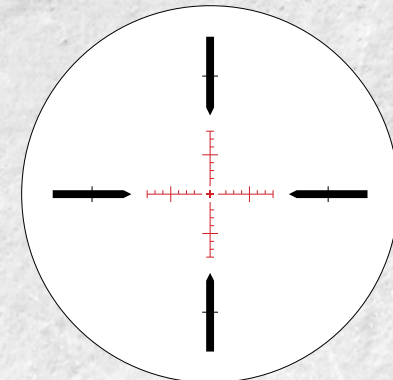

AHSR14 SFP IR MIL

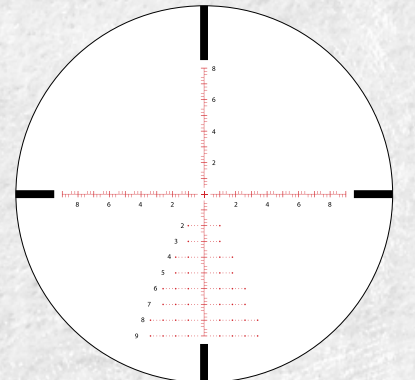

APLR2 FFP IR MIL

## PRODUCT SPECIFICATION

POWER X OBJECTIVE LENS	TURRET STYLE	TUBE SIZE	AVAILABLE RETICLES	SURFACE FINISH	EYE RELIEF	FOV @100 YARDS	WEIGHT	CLICK VALUE	ADJ. RANGE PER ROTATION	TOTAL ELEV. ADJ.	TOTAL WINDAGE ADJ.	PARALLAX ADJ.	PURGING MATERIAL	DIMENSIONS							
														L1	L2	L3	L4	L5	L6	D1	D2
1-4x24 SFP	EXPOSED	30 mm	AHSR14 SFP IR MIL	MATTE	6.26-3.5"	110-26 ft	18 oz	0.2 MIL	12 MIL	40 MIL	40 MIL	FIXED 100yds	NITRO-GEN	9.2"	/	5.6"	3.6"	1.9"	2.6"	1.8"	1.2"
4-14x44 FFP	EXPOSED	30 mm	APLR2 FFP IR MIL	MATTE	3.23-3.15"	27.2-7.9 ft	23.6 oz	0.1 MIL	5 MIL	20 MIL	20 MIL	SIDE FOCUS 10yds - ∞	NITRO-GEN	12.9"	3.9"	5.0"	4.0"	1.4"	2.0"	1.7"	1.8"

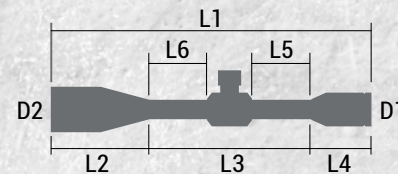

## KEY FEATURES



## OTHER FEATURES

Side Parallax Adjustment, Illuminated Glass Reticles, Exposed Turrets, First/Second Focal Plane





# TALOS RIFlescOPES



If you ask any hunter they'll tell you they have probably filled more tags in the low-light hours than any other time. The Talos scope with Fully Multi-Coated lenses for clarity and brightness in low light, you'll be able to add precious minutes to every hunting day that you've worked so hard for. These scopes, with their 4X magnification range, will give you great versatility whether you are hunting whitetails in the dense forest or prairie dogs in the wide open ranges. With its one-piece tube design, the Talos line includes an assortment of specialty scopes for big-game, varmint, MSR's, 22 rimfire, slug, black powder and turkey hunting.



3-12x40 mm



4-16x40 mm



6-24x50 mm

### KEY FEATURES



### OTHER FEATURES

Side Parallax Adjustment, 6063 Aluminum - 1 inch Tubes, Illuminated Glass Reticules, Capped Turrets, Second Focal Plane, Nitrogen Purging

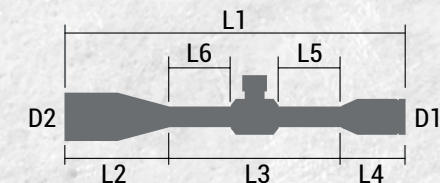

### AVAILABLE RETICLES

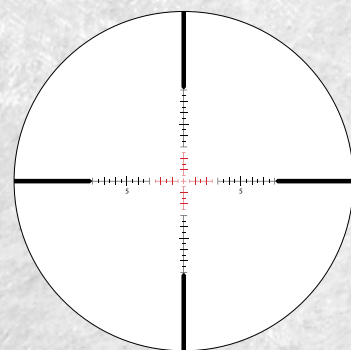

ATMR1 SFP IR MIL

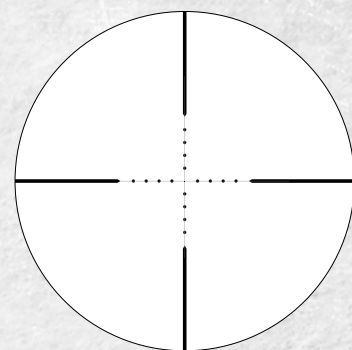

MIL-DOT

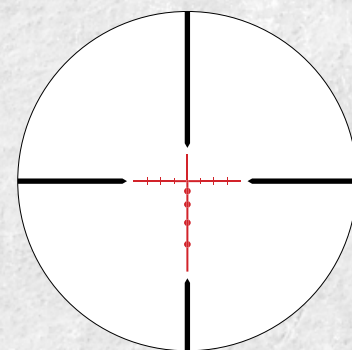

BDC 600 IR

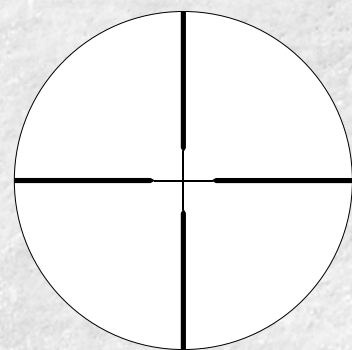

CENTER-X

### PRODUCT SPECIFICATION

POWER X OBJECTIVE LENS	TURRET STYLE	TUBE SIZE	AVAILABLE RETICLES	SURFACE FINISH	EYE RELIEF	FOV @100 YARDS	WEIGHT	CLICK VALUE	ADJ. RANGE PER ROTATION	TOTAL ELEV. ADJ.	TOTAL WINDAGE ADJ.	PARALLAX ADJ.	PURGING MATERIAL	DIMENSIONS							
														L1	L2	L3	L4	L5	L6	D1	D2
3-12x40 SFP	CAPPED	1"	BDC 600 IR	MATTE	3.82-3.35"	34.1 - 8.9 ft	16.2 oz	0.25 MOA	15 MOA	60 MOA	60 MOA	SIDE FOCUS 15yds - ∞	NITROGEN	12"	3.6"	4.8"	3.7"	1.9"	1.3"	1.8"	1.9"
			CENTER X																		
			MIL-DOT																		
4-16x40 SFP	CAPPED	1"	BDC 600 IR	MATTE	3.8-3.35"	24.1 - 6.3 ft	19.1 oz	0.25 MOA	15 MOA	50 MOA	50 MOA	SIDE FOCUS 15yds - ∞	NITROGEN	12.9"	3.5"	5.8"	3.7"	1.9"	2.2"	1.8"	1.9"
			MIL-DOT																		
6-24x50 SFP	CAPPED	1"	BDC 600 IR	MATTE	3.03-3.11"	16.8 - 4.5 ft	23 oz	0.25 MOA	15 MOA	60 MOA	60 MOA	SIDE FOCUS 10yds - ∞	NITROGEN	13.9"	4"	6.2"	3.7"	1.9"	2.7"	1.8"	2.2"
			ATMR1 SFP IR MIL																		





# NEOS RIFLESCOPES



Increasing your success while hunting doesn't necessarily have to decrease your savings account. The perfect example of that is the Neos series. This is the perfect scope for those who want quality and features all while staying on budget. The Neos has an impressive list of features which are designed and built to endure. It has a one piece aluminum tube. The lenses are Fully Multi Coated. Some of the models even have the latest side parallax focus technology. What about the cost? Let's just say the scope isn't the only thing that looks good, with ruggedness and precision we are proud of!



3-9x40 mm



4-12x40 mm



6-18x50 mm

### KEY FEATURES



### OTHER FEATURES

Second Focal Plane Reticle, Side Parallax Adjustment, 6063 Aluminum - 1 inch Tubes, Illuminated Glass Reticles, Capped Turrets, Nitrogen Purging

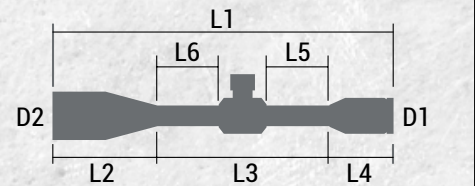

### AVAILABLE RETICLES

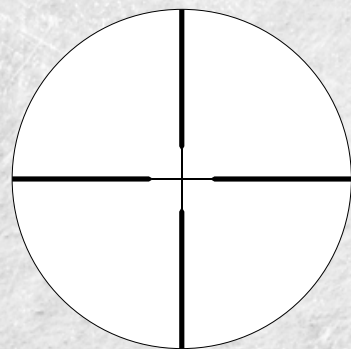

CENTER-X

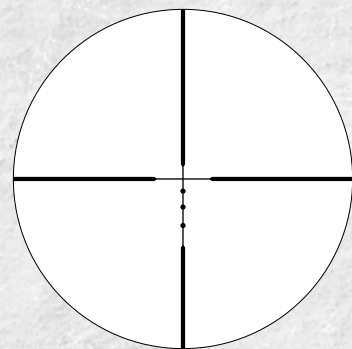

BDC 22 RIMFIRE

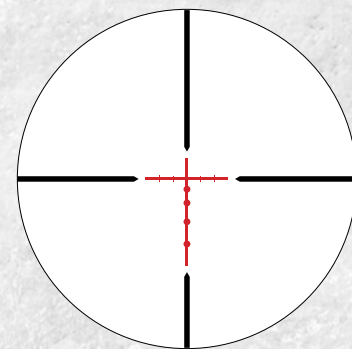

BDC 500 IR

### PRODUCT SPECIFICATION

POWER X OBJECTIVE LENS	TURRET STYLE	TUBE SIZE	AVAILABLE RETICLES	SURFACE FINISH	EYE RELIEF	FOV @100 YARDS	WEIGHT	CLICK VALUE	ADJ. RANGE PER ROTATION	TOTAL ELEV. ADJ.	TOTAL WINDAGE ADJ.	PARALLAX ADJ.	PURGING MATERIAL	DIMENSIONS							
														L1	L2	L3	L4	L5	L6	D1	D2
3-9x40 SFP	CAPPED	1"	CENTER X BDC 500 IR BDC 22 RIMFIRE	MATTE	2.99-3.07"	37.8-12.6 ft	17 oz	0.25 MOA	15 MOA	80 MOA	80 MOA	FIXED 100 yds	NITROGEN	12.4"	3.3"	5.6"	3.5"	2.3"	2.3"	1.6"	1.9"
4-12x40 SFP	CAPPED	1"	CENTER X BDC 500 IR BDC 22 RIMFIRE	MATTE	3.11-3.15"	27.3-8.9 ft	18.1 oz	0.25 MOA	15 MOA	80 MOA	80 MOA	SIDE FOCUS 10 yds - ∞	NITROGEN	12.4"	3.3"	5.6"	3.5"	2.3"	2.3"	1.6"	1.9"
6-18x44 SFP	CAPPED	1"	CENTER X BDC 500 IR	MATTE	3.39-3.19"	17.5-5.9 ft	21.7 oz	0.25 MOA	15 MOA	80 MOA	80 MOA	SIDE FOCUS 10 yds - ∞	NITROGEN	13.5"	3.7"	6.3"	3.5"	2.3"	3"	1.6"	2"



# CRONUS TACTICAL UHD

## SPOTTING SCOPES

Whether you are a long range shooter, hunter or part of a sniper team, the new Cronus Tactical 7-42x60 Spotting Scope with our ranging reticle will make your job a breeze. The TSSR FFP MIL reticle is great for both range estimation and tactical cooperation with the shooter. Feature rich from tip to tip, this is an optic that will not be left behind. The unique design of a high riser mount will allow you to mount your Athlon Laser Rangefinders on the top and tilt it to co-witness with your spotting scope.



### AVAILABLE RETICLES

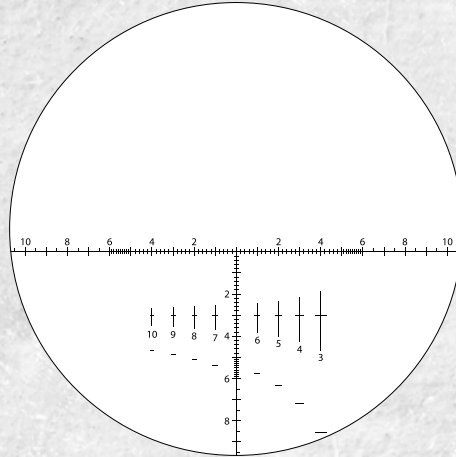

TSSR FFP

\* The rail mounting system is included in both models

### PRODUCT SPECIFICATION

POWER X OBJECTIVE LENS	OBJ. LENS DIA.	FOCUS RANGE	AVAILABLE RETICLES	EYE RELIEF	FOV @1000 YARDS	WEIGHT	LENGTH
7-42x60 UHD FFP	60 mm	10 yds - ∞	TSSR FFP MIL	1.18"	284 - 47.6 ft	46.6 oz	13.9"

### KEY FEATURES



### OTHER FEATURES

Aluminum Alloy Chassis,  
Ranging Reticle, Tripod Adaptable,  
Rubber Armor





# CRONUS UHD SPOTTING SCOPES

You've just adjusted focus on what had once been only an elusive lifelong quest- an Alaskan Bighorn or a Red-Throated Pipit. We developed this "Award Winning" Cronus Spotting Scope to give you one of world's best optics with brighter and clearer edge-to-edge detail. So whether you're hunting above timberline in Alaska or birding at sea level at Cape May, you will know every detail of your trophy before you take the shot or mark it off your life list. The Cronus product line has just about every feature you would put in a scope to make it the best you can get in its class.

We designed the Cronus with the Apochromatic system to give your images greater contrast, sharpness and color definition. We included ED Glass that delivers clearer and sharper image to your eyes. Our state of the art ESP (Enhance Spectral Prism) dielectric lens coating that reflects 99% of the light through the prism assembly. Other design enhancements include BaK-4 prisms and our "Advanced Fully Multi-Coated" lenses deliver flawless color fidelity, ultra-crisp images and optimum light transmission. Finally we topped off with our XPL coating that gives you extra protection on the exterior lenses from dirt, oil and scratches.



## PRODUCT SPECIFICATION

MAGNIFICATION X OBJECTIVE LENS	EYEPIECE ANGLE	EYE RELIEF	CLOSE FOCUS	FOV @1000 YARDS	WEIGHT	LENGTH X WIDTH
20-60x86 UHD	45	0.78"	29.5 ft	117 - 60 ft	66.5 oz	13.6 x 3.9"
12-36x50 UHD	45	0.7"	26.2 ft	171 - 90 ft	26.5 oz	9.8 x 2.6"

## KEY FEATURES



## OTHER FEATURES

BaK4 Prisms, Magnesium Chassis, Waterproof, Dual Focus, Rotating Ring, Twist Up Eye-Cup, Tripod Adaptable





# ARES UHD/ ARES G2 UHD SPOTTING SCOPES

The Ares family of spotting scopes were designed with advanced optical quality and ease of use in mind, so when you are trying to collect that trophy of a lifetime, your spotting scope is one thing you don't have to worry about. We made that task as easy as optically possible with bright, razor-sharp imagery and a rugged, weatherproof design that's ready for any condition. These spotting scopes have ED glass lenses for color resolution and contrast. They also have our AFMC (Advanced Fully Multi-Coated Lenses) and feature BaK4 prisms with the new ESP Dielectric Coating. They bring super-premium clarity and brightness within the reach of most avid enthusiasts. The tough chassis is fog proof and waterproof and filled with Argon gas to prevent internal fogging and for better thermal stability.

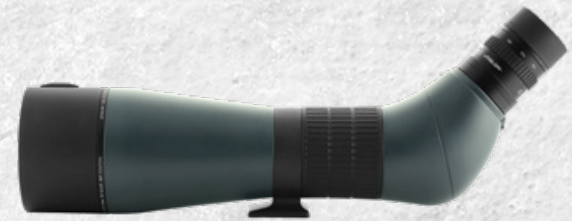

20-60x85 mm UHD

NEW



15-45x65 mm G2 UHD

NEW



15-45x65 mm G2 UHD

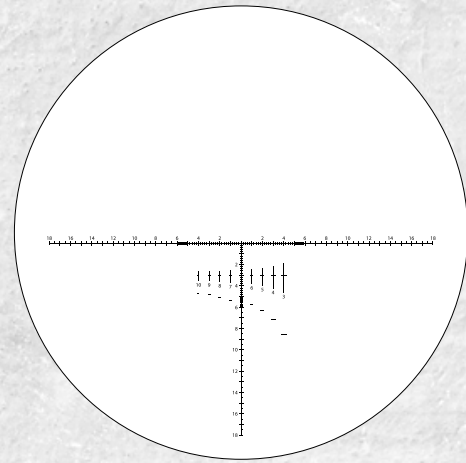

TSSR2 SFP MIL

\*24 magnification eyepiece with TSSR2 reticle

## PRODUCT SPECIFICATION

MAGNIFICATION X OBJECTIVE LENS	EYEPIECE ANGLE	EYE RELIEF	CLOSE FOCUS	FOV @1000 YARDS	WEIGHT	LENGTH X WIDTH
20-60x85 UHD	45 DEGREE	0.78"	29.5 ft	102 - 51 ft	66.5 oz	15.7x3.9"
15-45x65 UHD	45 DEGREE	0.75"-63"	13.1 ft	171 - 81 ft	45.9 oz	11.9x3.0"
15-45x65 UHD	STRAIGHT	0.75"-63"	13.1 ft	171 - 81 ft	49.3 oz	13.5x3.0"

\*A 24 magnification eyepiece with MIL reticle can be swapped with the regular eyepiece of the 15-45x65 model.

## KEY FEATURES



## OTHER FEATURES

BaK4 Prisms, Magnesium Chassis, Waterproof, Dual Focus, Rotating Ring, Twist Up Eye-Cup, Tripod Adaptable





# ARGOS HD SPOTTING SCOPES

Whether helping your buddy sight in his rifle, or spotting for others at a PRS match, spotting scopes are becoming a necessary item on everyone's equipment list. A lightweight option for hunting and birding, the composite chassis on the Argos spotting scope has rubber armor for an extra layer of protection. No matter what position you find yourself in, the spotting scope can be orientated to a comfortable position using the rotating lock ring. Advanced Fully Multi-coated lenses and nitrogen purging provide great light transmission and weather-proofing.

NEW



20-60x85 HD

NEW



20-60x85 HD

### PRODUCT SPECIFICATION

MAGNIFICATION X OBJECTIVE LENS	EYEPIECE ANGLE	EYE RELIEF	CLOSE FOCUS	FOV @1000 YARDS	WEIGHT	LENGTH X WIDTH
20-60x85 HD	45 DEGREE	.77"- .70"	39.4 ft	102 - 48 ft	70 oz	16.9x4.01"
20-60x85 HD	STRAIGHT	.77"- .70"	39.4 ft	102 - 48 ft	68.9 oz	16.9x4.01"

### KEY FEATURES



### OTHER FEATURES

Composite Chassis, Waterproof, Fog Proof, Rotating Ring, Twist Up Eye-Cup, Tripod Adaptable





# MIDAS RED DOT SIGHTS

The speed and versatility of a Red Dot goes unmatched in close range engagements. Whether you are running an AR or PCC in competition, hunting, or running a Red Dot on an optics ready pistol, the TSR series of Red Dots has you covered. With 50,000 hours of battery life and motion sensor activation, the TSR series is always ready. The TSR1 features a 3MOA red dot, quickly allowing the pistol shooter to acquire the red dot while focusing on the targets. The TSR2 and TSR3 both have 2MOA red dots. This smaller red dot minimizes target obstruction, aiding in precision shooting.

NEW



TSR1 Red Dot

NEW



TSR2 Red Dot

NEW



TSR3 Red Dot

## KEY FEATURES

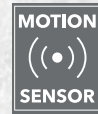

## OTHER FEATURES

Nitrogen Purging, Adjustable Illumination Settings, Aircraft Aluminum, One Piece Chassis Construction, Fog Proof, Shockproof, Picatinny Rail Mount

## AVAILABLE RETICLES

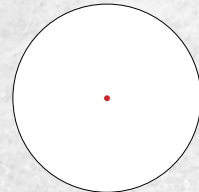

TSR1 / TSR2 / TSR3

## PRODUCT SPECIFICATION

AVAILABLE MODELS	OBJECTIVE LENS	POWER	PARALLAX	AVAILABLE RETICLES	DOT COLOR	IR SETTING	CENTER HEIGHT	CLICK VALUE	TURRET CONTROL	BATTERY	BASE	WEIGHT	LENGTH
TSR1	24 x 17 mm	1	0 MOA	TSR1	Red	1-10	.96"	1 MOA	WRENCH	CR2032	Picatinny Rail Mount	2.8 oz	1.88"
TSR2	20 mm	1	<1 MOA	TSR2	Red	1-13	*1.59"	.5 MOA	CAPPED	AAA	Picatinny Rail Mount	6.7 oz	2.79"
TSR3	36 mm	1	<1 MOA	TSR3	Red	1-13	1.39"	.5 MOA	CAPPED	CR2032	Picatinny Rail Mount	10.6 oz	3.73"

\*Measured with Hi-Riser Mount





# MIDAS PRISM SCOPES

When you want quick target acquisition at both short and medium ranges you need additional magnification. Athlon prism scopes give you great versatility. This optic is equipped with a prism for a crisp, vivid image. The prism-based design allows for a more compact scope without sacrificing optical quality. With this longer focal length it can achieve the magnification needed to reach out and touch targets at longer ranges. Athlon prism scopes are nitrogen-filled, fog proof and shock proof, allowing for reliable use in a wide range of environments. Featuring a selectable red/green illuminated reticle with multiple intensity levels to match your specific conditions. The reticles are etched directly on the glass to make sure you have consistent point-of-aim at all times. Whether you have the illumination on or off, the reticle is always visible.



TSP3 (32 mm O.B.J.)



TSP4 (34 mm O.B.J.)

### KEY FEATURES



### OTHER FEATURES

Nitrogen Purging, Adjustable Illumination Settings, Aircraft Aluminum, One Piece Chassis Construction, Fog Proof, Shockproof, Picatinny Rail Mount, Auto power shut-off (6 hours), Capped Turrets

### AVAILABLE RETICLES

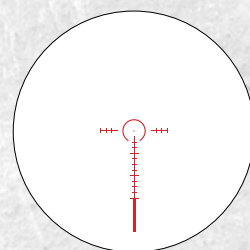

TSP3

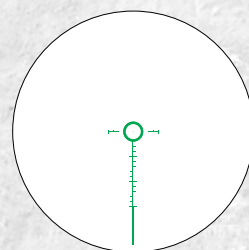

TSP4

\*User selectable red/green illumination, black reticle (off)

### PRODUCT SPECIFICATION

AVAILABLE MODELS	OBJECTIVE LENS	MAGNIFICATION	FOV @100 YARDS	AVAILABLE RETICLES	RETICLE COLOR	CENTER HEIGHT	CLICK VALUE	TURRET CONTROL	BATTERY	BASE	WEIGHT	LENGTH
TSP3	27.5 mm	3	34 ft	TSP3	Red/Green	1.39"	0.5 MOA	CAPPED	CR2032	Picatinny Rail Mount	15.1 oz	4.6"
TSP4	29.5 mm	3.9	9 ft	TSP4	Red/Green	1.39"	0.5 MOA	CAPPED	CR2032	Picatinny Rail Mount	17.4 oz	5.3"





# MIDAS MAGNIFIERS

Many times when in the field or during competitions you need to transition between no magnification for speed in close-range combat and magnification for precision shooting as situation dictates.

The Athlon 3 or 5 power magnifier mounts behind a traditional red-dot sight to provide magnification when needed. The mount has the ability to swing out of the way when not in use, but can quickly be placed behind the Red Dot to increase the magnification for longer mid-range shots. Rugged construction. Multi-coated lenses and 30mm tube for excellent light transmission. Nitrogen purged, shockproof, waterproof, and fogproof.



MG31 - Flip Mount with Riser



MG51 - Flip Mount with Riser

## KEY FEATURES



**The Aircraft Grade Aluminum** that has exceptional strength and superior mechanical integrity will protect these world class optics no matter what punishment you throw at it.

## OTHER FEATURES

Fog Proof,  
Shockproof,  
Nitrogen Purging,  
One Piece Chassis Construction  
Flip Mount with riser

## PRODUCT SPECIFICATION

AVAILABLE MODELS	OBJ. LENS DIAMETER	MAGNIFICATION	FOV @100 YARDS	EYE RELIEF	WEIGHT	LENGTH	*CENTER HEIGHT	**CENTER HEIGHT
MG31	27.5 mm	3	38.2 ft	2.8"	9.5 oz	4.2"	1.32"	1.56"
MG51	30 mm	5	24.7 ft	2.6"	12.6 oz	4.8"	1.32"	1.56"

\* Standard flip mount; \*\* Standard flip mount with riser







# MIDAS 1200Y RANGEFINDERS

The Athlon Optics Midas 1200y Laser Rangefinder is in a class of its own. The Midas 1200 ranges quick and accurate from 5 to 1200 yards. Whether shooting from steep elevations to flat ground, the Midas is capable of both with our angle compensation and line of sight modes.

The scan mode can quickly scan different objects for distances on the fly. Bright display settings with Fully Multi-Coated lenses deliver maximum light transmission while being housed in durable non slip rubber armor.

The Midas can display readings in either yards or meters depending on your hunting or shooting needs. Finally the Midas comes with a protective carrying case as well as a protective wrap that allows you to use the laser while protecting it at the same time.



1200Y - TAN



1200Y - GREY



## THREE RANGING MODES TO CHOOSE FROM

**Incline Angle (T)** mode displays the incline angle of your position to the target.

**Horizontal Distance (H)** mode displays the angle compensated distance to the target. This is the primary mode used by most hunters (Both bow and rifle).

**Vertical Distance (V)** mode displays the vertical distance of your position to the target.

**Scan Mode** displays distance readings quickly as you pan across a target, landscape or a moving animal

## PRODUCT SPECIFICATION

RANGING REFLECTIVE	RANGING DEER	ACCURACY	MAX ANGLE READING	MAGNIFICATION	OBJ. LENS DIAMETER	FOV	EYE RELIEF	POWER SUPPLY
1200 Y	600 Y	±0.5Y	±70°	6X	23.5mm	7°	14mm	CR2-3V

## KEY FEATURES



## OTHER FEATURES

Nitrogen Purging, Tripod Adaptable, Scan Mode, Dual Units of Measurement of Distance (Y/M), Angle Compensation Mode, Diopter Adjustment



# MIDAS 1 MILE RANGEFINDER

Whether shooting from steep elevations to flat ground, the Midas is capable of both with our different ranging modes. Bright display settings with fully multi-coated lenses deliver maximum light transmission while being housed in durable non-slip rubber armor. The Midas can display reading in either yards or meters depending on your hunting or shooting needs.

Finally the Midas comes with a protective carrying case as well as a protective wrap that allows you to use the laser while protecting it at all the same time. Backed with our Lifetime Warranty.



1 MILE - GREY

## PRODUCT SPECIFICATION

RANGING REFLECTIVE	RANGING DEER	ACCURACY	MAX ANGLE READING	MAGNIFICATION	OBJ. LENS DIAMETER	FOV	EYE RELIEF	POWER SUPPLY
1700 Y	800 Y	±0.5Y	±70°	6X	23.5mm	7°	14mm	CR2-3V

## KEY FEATURES



## OTHER FEATURES

Nitrogen Purging, Tripod Adaptable, Scan Mode, Dual Units of Measurement of Distance (Y/M), Angle Compensation Mode, Diopter Adjustment







### CRONUS BTR UHD ATSR2 SFP IR MOA

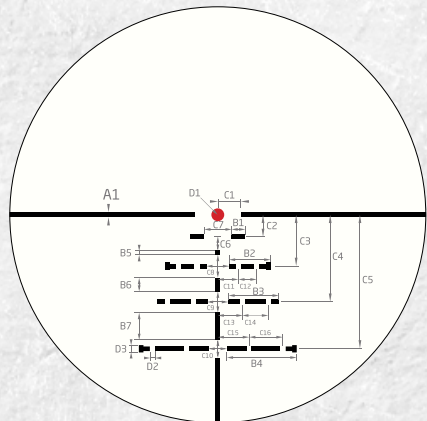

**ATSR2 SFP IR MOA** Designed around the .223/5.56mm using a 69 grain Sierra Match King and a 200 yard zero. The open center design allows shooters to engage 12-18" targets out to 600 yards by quickly bracketing the target. Subtension holds for 300, 400, 500, and 600 yards are calibrated to compensate for 0, 5, and 10 MPH winds. The 3-post cross hair design quickly draws the shooter's attention to the illuminated center dot. Perfect for 3-gun competitions or the hunter looking for short to midrange engagement when seconds matter.

### CRONUS BTR UHD APRS FFP IR MIL

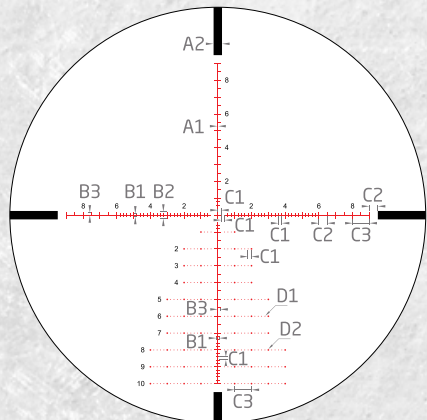

**APRS FFP IR MIL** reticle is designed for precision rifle series competition and any other long range shooting applications with accurate ranging capability. It can help you quickly determine distance, holdover positions, windage correction and leads for a moving target. The unique design of fine .2 mil hash mark increments from center to 6 mils to both left and right helps the shooter set a quick windage holdover position after he or she dials in elevation on their targets. The floating 0.4 mil span center cross draws a shooter's vision right on target enabling him or her to engage a target at a blink of an eye.

### CRONUS BTR UHD APLR FFP IR MOA

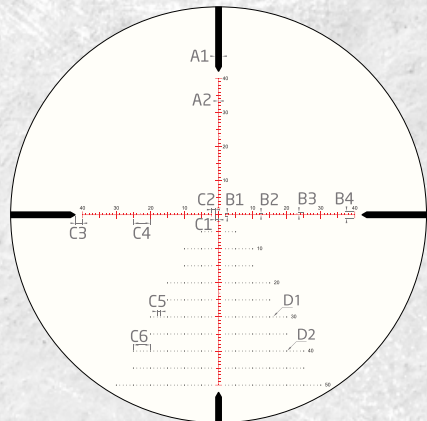

**APLR FFP IR MOA** reticle has a large illuminated center with 1 moa incremental hash marks and drop lines in 5 moa incremental on vertical direction down to 50 moa, which help you quickly lock in your target and set holdover positions. The illuminated portion has a 2 moa center cross and 40 moa cross lines (50 moa on lower vertical line). The drop lines have smaller dots with 1 moa in between and bigger dots at each 5 moa interval. The illuminated reticle provides excellent low light visibility and accurate elevation holdovers all the way up to 50 moa.

### CRONUS BTR UHD APRS1 FFP IR MIL

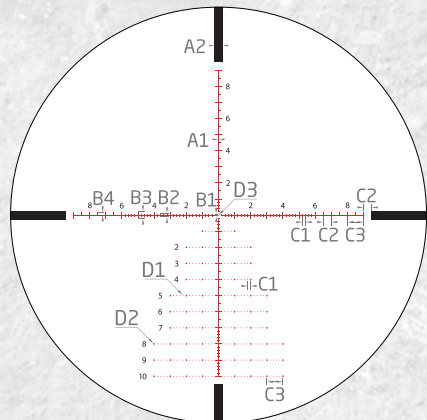

**APRS1 FFP IR MIL** reticle is designed for precision rifle series competition and any other long range shooting applications with accurate ranging capability. It can help you quickly determine distance, holdover positions, windage correction and leads for a moving target. The unique design of fine .2 mil hash mark increments from center to 6 mils to both left and right helps the shooter set a quick windage holdover position after he or she dials in elevation on their targets. The floating 0.04 center dot draws a shooter's vision right on target enabling him or her to engage a target at a blink of an eye.

### CRONUS BTR UHD /ARES ETR UHD APLR5 FFP IR MOA

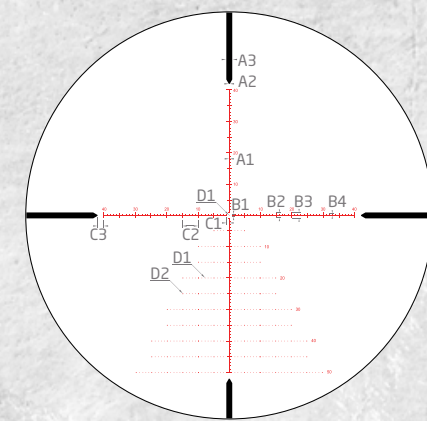

**APLR5 FFP IR MOA** reticle is designed for precision rifle series competition and any other long range shooting applications with accurate ranging capability. It can help you quickly determine distance, holdover positions, windage correction and leads for a moving target. The unique design of the fine 1 MOA hash mark increments from center to 40 MOA to both left and right helps the shooter determine a quick windage holdover position after he or she dialed in elevation on their targets. The floating 0.2 MOA center dot draws a shooter's vision right on target enabling him or her to engage a target at a blink of an eye.

### ARES ETR UHD APRS1 FFP IR MIL

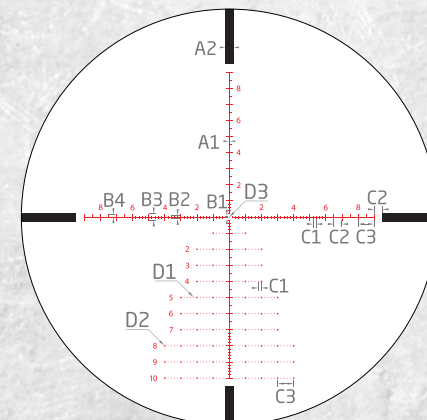

**APRS1 FFP IR MIL** reticle is designed for precision rifle series competition and any other long range shooting applications with accurate ranging capability. It can help you quickly determine distance, holdover positions, windage correction and leads for a moving target. The unique design of fine .2 mil hash mark increments from center to 6 mils to both left and right helps the shooter set a quick windage holdover position after he or she dialed in elevation on their targets. The floating 0.03 center dot draws a shooter's vision right on target enabling him or her to engage a target at a blink of an eye.

### ARES ETR UHD APLR2 FFP IR MOA

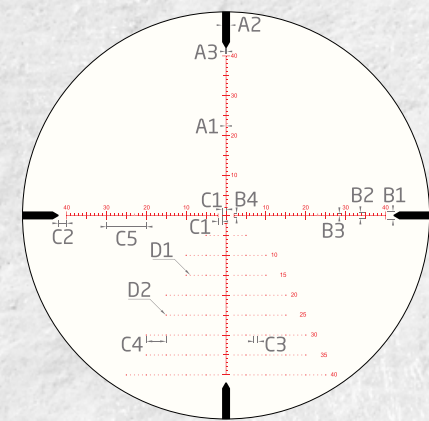

**APLR2 FFP IR MOA** reticle has a large illuminated center with 1 moa hash mark increments and drop lines in 5 moa increment on vertical direction down to 40 moa, both of which help you quickly lock in your target and set holdover positions. The illuminated portion has a 2 moa span center cross with illuminated cross line extends to 40 moa on both vertical and horizontal direction. The unique design of having droplines going down to 40 moa with 5 moa between each drop line and 1 moa hash marks in between provide excellent hold over positions for long precision shooting.

### ARES BTR GEN2 HD APLR3 FFP IR MOA

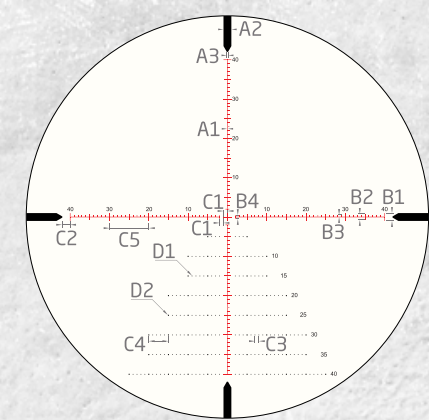

**APLR3 FFP IR MOA** reticle has a large illuminated center with 1 moa hash mark increments and drop lines in 5 moa increment on vertical direction down to 40 moa, both of which help you quickly lock in your target and set holdover positions. The illuminated portion has a 2 moa span center cross with illuminated cross line extends to 40 moa on both vertical and horizontal direction. The unique design of having droplines going down to 40 moa with 5 moa between each drop line and 1 moa hash marks in between provide excellent hold over positions for long precision shooting.

ATSR2 SFP IR MOA	A1	B1	B2	B3	B4	B5	B6	B7	C1	C2	C3	C4	C5	C6	C7	C8	C9	C10	C11	C12	C13	C14	C15	C16	D1	D2	D3
	.5	1.5	4.5	5.5	7.6	.45	1.5	2.95	2.5	2.4	5.6	9.5	14.6	1.5	3	2.5	2.3	2	2.25	2	2.7	2.8	3.4	3.7	1.4	.6	.8
APLR FFP IR MOA	A1	A2	B1	B2	B3	B4	C1	C2	C3	C4	C5	C6	D1	D2													
	2	.14	1	.5	1.5	2	1	1	2	5	1	5	.2	.3													
APRS FFP IR MIL	A1	A2	B1	B2	B3	C1	C2	C3	D1	D2																	
	.03	.05	.18	.4	.15	.2	.5	1	.05	.1																	
APRS1 FFP IR MIL	A1	A2	B1	B2	B3	B4	C1	C2	C3	D1	D2	D3															
	.025	.5	.1	.18	.4	.15	.2	.5	1	.05	.1	.04															

APLR5 FFP IR MOA	A1	A2	A3	B1	B2	B3	B4	C1	C2	C3	D1	D2													
	.13	.3	3	.6	1.5	2	.5	1	5	2	.2	.3													
APRS1 FFP IR MIL	A1	A2	B1	B2	B3	B4	C1	C2	C3	D1	D2	D3													
	.03	.5	.1	.18	.4	.15	.2	.5	1	.05	.1	.03													
APLR2 FFP IR MOA	A1	A2	A3	B1	B2	B3	B4	C1	C2	C3	C4	C5	D1	D2											
	.11	2	.3	2	1.5	.5	1	1	2	1	5	10	.2	.3											
APLR3 FFP IR MOA	A1	A2	A3	B1	B2	B3	B4	C1	C2	C3	C4	C5	D1	D2											
2.5-15x50	.24	2	.3	2	1.5	.5	1	1	2	1	5	10	.2	.3											
4.5-27x50	.14	2	.3	2	1.5	.5	1	1	2	1	5	10	.2	.3											

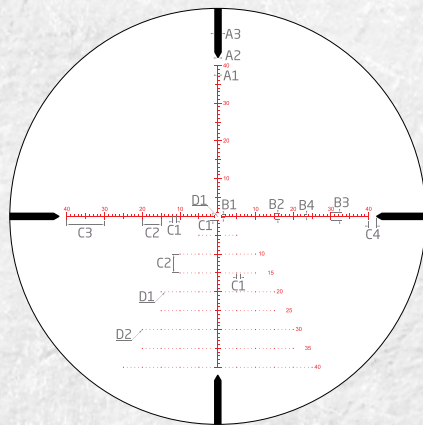

**ARES BTR GEN2 HD**  
 APLR4 FFP IR MOA

**ATSR2 SFP IR MOA** is a long awaited addition for those who prefer MOA-based reticles. The floating dot, popular with precision shooters, is now available in the Ares BTR line. At .2 MOA, this dot is roughly the size of a bullet hole at 100 yards, giving you the possibly of shooting your tightest group. Fine tuning your zero is a breeze with 1 MOA elevation and windage hash marks, saving the shooter both time and bullets when estimating corrections.

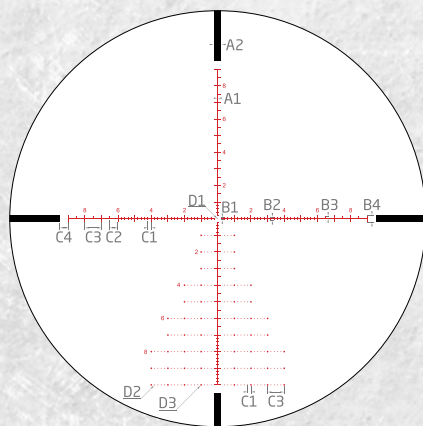
**ARES BTR GEN2 HD**  
 APRS5 FFP IR MIL

**APRS FFP IR MIL** reticle is perfect for fast corrections on windy days. Designed to help shooters determine proper windage and elevation corrections quickly, without being too busy. A precise .05 MIL floating dot in the center of the reticle reduces target obstruction. With elevation hash marks of .2 MILS extending from the center to 1 MIL, and windage hash marks of .2 MIL increments extending out 6 MILS from center. This configuration is ideal for fast corrections on near misses if you've misjudged the wind or target distance.

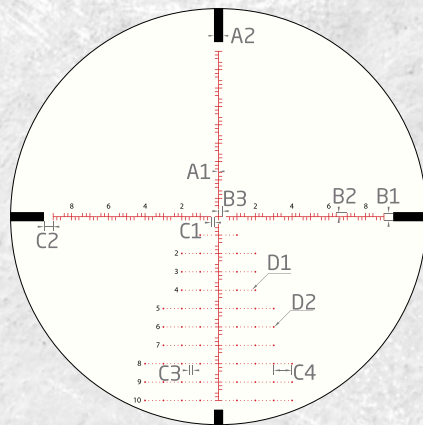
**ARES BTR GEN2 HD**  
 APLR3 FFP IR MIL

**APLR3 FFP IR MIL** reticle can help you quickly determine distance, holdover positions, windage correction and leads for a moving target. The unique design of fine .2 mil hash mark increments from center all the way to four directions helps the shooter set a precise holdover position for their targets within a blink of an eye. The illuminated fine reticle provides excellent low light visibility and windage holdovers on the bullet droplines all the way up to 10 mils with .2 mil marks increments in between.

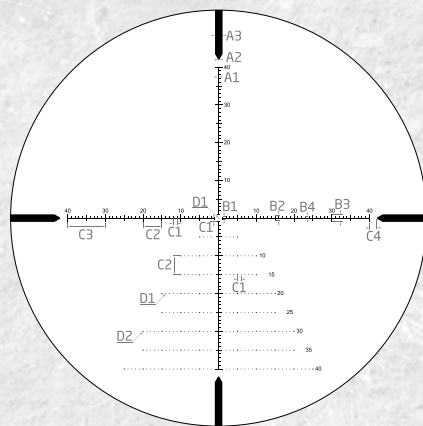
**MIDAS TAC HD**  
 APLR4 FFP MOA

**APLR4 FFP MOA** reticle is a blend of precision marksman and long-range hunter. The open center design eliminates target obstruction by utilizing a .2 MOA diameter dot. 1 MOA hashmark increments provide fast holdovers up to 40 MOA, compensating for both windage and elevation.

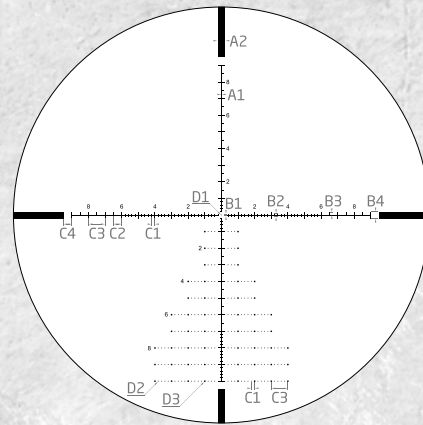
**MIDAS TAC HD**  
 APRS3 FFP MIL

**APRS3 FFP MIL** reticle is a dual use design. Allowing the shooter to accurately range and compensate windage and elevation holdovers should they prefer not to make turret elevation adjustments between shots. Quick windage or lead holdovers is possible due to the .2 Mil increment hash marks. This open-center reticle features a .05 Mil floating dot, quickly drawing the shooters attention to the center.

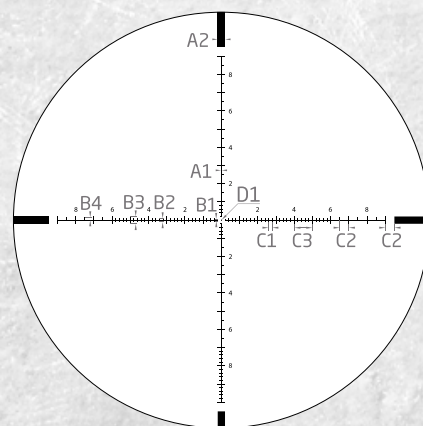
**MIDAS TAC HD**  
 APRS2 FFP MIL

**APRS2 FFP MIL** reticle is designed for precision rifle series competition and any other long range shooting applications with accurate ranging capability. It can help you quickly determine distance, holdover positions and windage corrections. The unique design of fine .2 mil hash mark increments from center to 6 mils to both left and right helps the shooter set a quick windage holdover position after he or she dialed in elevation on their targets. The floating 0.05 (0.06) center dot draws a shooter's vision right on target enabling him or her to engage a target at a blink of an eye.

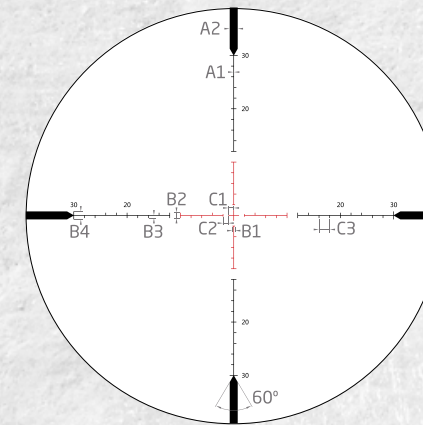
**MIDAS HMR HD**  
 AHMR SFP IR MOA

**AHMR SFP IR MOA** reticle has an illuminated 20 moa center with a 2 moa center cross and 2 moa incremental hash marks which provide a unique two layer visual reference for a shooter to locate and get dead on the target within a blink of an eye. The illuminated reticle provides excellent low light visibility. The unique design of the markings with 2 & 4 moa and 6 & 8 moa locating at the opposite side of the lines gives you a clear reading of the markings with no confusions.

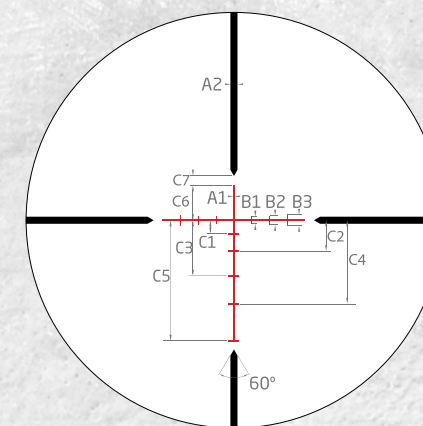
**MIDAS HMR HD**  
 BDC 600A IR

**BDC 600A IR** reticle can be used effectively with a variety of firearms giving your accurate ranges and reference marks which can be used to compensate for bullet drift in windy conditions or range distances. The user can sight in at 100 yards on any magnification setting, but for the ballistic reticle feature to function properly, the scope's magnification must be set to the correct power as follows: 2.5-15x50 (15x power)

APLR4 FFP IR MOA	A1	A2	A3	B1	B2	B3	B4	C1	C2	C3	C4	D1	D2
	.12	.3	2	.6	1.5	2	.5	1	5	10	2	.2	.3
APRS5 FFP IR MIL	A1	A2	B1	B2	B3	B4	C1	C2	C3	C4	D1	D2	D3
	.03	.4	.1	.18	.15	.4	.2	.5	1	.5	.05	.05	.1
APLR3 FFP IR MIL	A1	A2	B1	B2	B3	C1	C2	C3	C4	D1	D2		
2.5-15x50	.07	.5	.4	.2	.2	.2	.5	.2	1	.09	.14		
4.5-27x50	.04	.5	.4	.2	.2	.2	.5	.2	1	.05	.1		
APLR4 FFP MOA	A1	A2	A3	B1	B2	B3	B4	C1	C2	C3	C4	D1	D2
	.12	.3	2	.6	1.5	2	.5	1	5	10	2	.2	.3

APRS3 FFP MIL	A1	A2	B1	B2	B3	B4	C1	C2	C3	C4	D1	D2	D3
	.03	.4	.1	.18	.15	.4	.2	.5	1	.5	.05	.05	.1
APRS2 FFP MIL	A1	A2	B1	B2	B3	B4	C1	C2	C3	D1			
4-16x44	.04	.4	.1	.18	.4	.15	.2	.5	1	.06			
6-24x50	.03	.4	.1	.18	.4	.15	.2	.5	1	.05			
AHMR SFP IR MOA	A1	A2	B1	B2	B3	B4	C1	C2	C3				
subtension valid @ 15x	.12	1.5	.5	1	.5	1.5	1	1	2				
BDC 600A IR (MOA)	A1	A2	B1	B2	B3	C1	C2	C3	C4	C5	C6	C7	
subtension valid @ 15x	.15	.6	.8	1	1.2	1.5	3.5	6.25	9.5	13.6	4	1	



### MIDAS BTR GEN2 HD ATSR16 SFP IR MOA

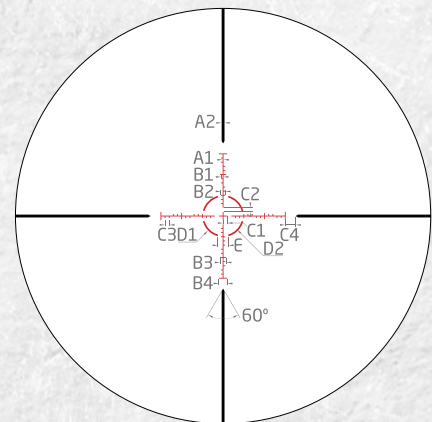

**ATSR16 SFP IR MOA** reticle has a large illuminated center and 2 moa incremental hash marks, which help you quickly lock in your target and set holdover positions. The illuminated center with a 20 moa diameter circle in the middle has a 2 moa center cross and 2 moa incremental hash marks extended to 30 moa at each direction on both vertical and horizontal lines. The cross lines, middle circle, and center cross provide a unique three layer visual reference for a shooter to locate the target and set dead on the center cross within a blink of an eye.

### MIDAS BTR GEN2 HD AHMR SFP IR MOA

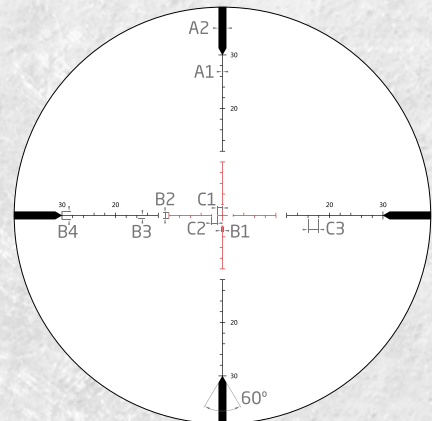

**AHMR SFP IR MOA** reticle has an illuminated 20 moa center with a 2 moa center cross and 2 moa incremental hash marks which provide a unique two layer visual reference for a shooter to locate and get dead on the target within a blink of an eye. The illuminated reticle provides excellent low light visibility. The unique design of the markings with 2 & 4 moa and 6 & 8 moa locating at the opposite side of the lines gives you a clear reading of the markings with no confusion.

### MIDAS BTR GEN2 HD APRS4 SFP IR MIL

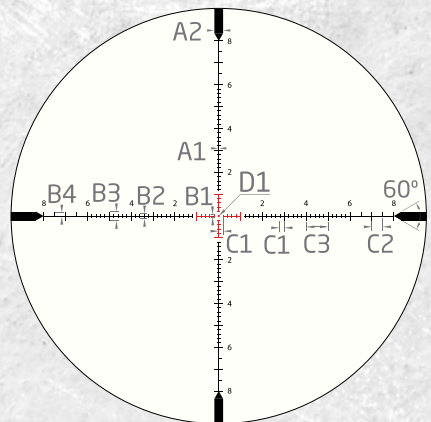

**APRS4 SFP IR MIL** reticle has an illuminated 2 MIL center cross with an open center. A fine .1 diameter floating dot reduces target obstruction, while the illuminated cross provides excellent low light visibility. .2 Mil incremental hashmarks out to 6 Mils for windage and elevation makes estimations easy.

### MIDAS BTR GEN2 HD ATSR4 SFP IR MOA

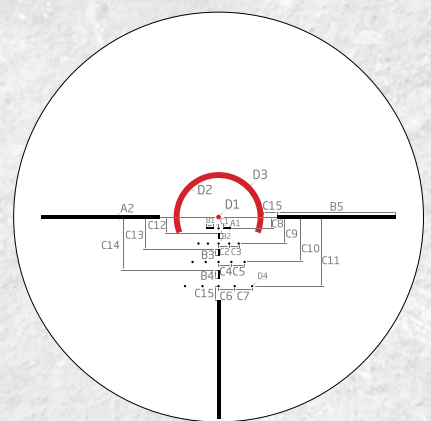

**ATSR4 SFP IR MOA** reticle is designed for quick target acquisition, speed, and precision shooting in short to mid-range environments. Ideal for CQC and 3-gun competition, this reticle is calibrated for a 68 grain Hornady and 69 grain Sierra cartridges, and suitable for any 5.56 Nato/.223 caliber rifle using a 200 yard zero. The 25 MOA horizontal and lower 1/3rd crosshairs quickly draw the shooters eye to the illuminated 19 MOA horseshoe and 1.4 MOA center dot. With a 200 yard zero, the precise .5 MOA elevation holds compensate for 300, 400, 500, and 600 yards and 0, 5 and 10 MPH winds.

### HELOS BTR ATSR3 SFP IR MOA

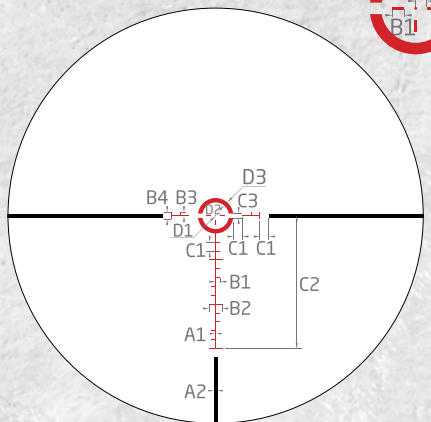

**ATSR3 SFP IR MOA** is designed for High Power Service Rifle matches. A 12 MOA center circle outlines a 8 MOA floating cross with a precise .5 MOA center dot. The outer circle helps the shooter find the quickly, while the .5 MOA floating dot allows for precise shot placement. Illuminated subtensions provide contrast between the reticle and target.

### HELOS BTR APLR2 FFP IR MOA

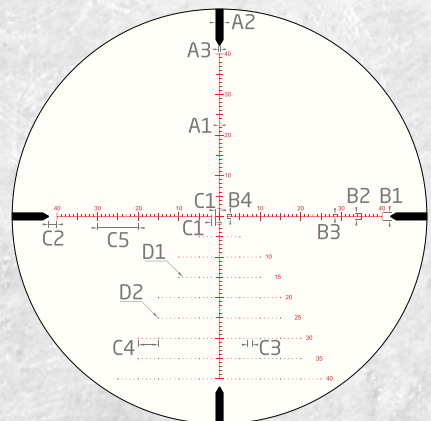

**APLR2 FFP IR MOA** reticle has a large illuminated center with 1 moa hash mark increments and drop lines in 5 moa increment on vertical direction down to 40 moa, both of which help you quickly lock in your target and set holdover positions. The illuminated portion has a 2 moa span center cross with illuminated cross line extends to 40 moa on both vertical and horizontal direction. The unique design of having droplines going down to 40 moa with 5 moa between each drop line and 1 moa hash marks in between provide excellent hold over positions for long precision shooting.

### HELOS BTR APMR FFP IR MIL

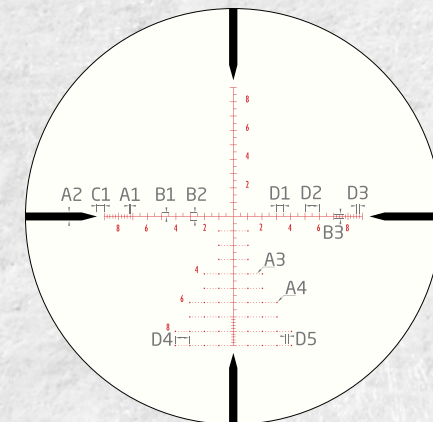

**APMR FFP IR MIL** reticle is designed to maximize your performance on long and mid-distance shooting with illuminated center cross and 0.5 mil hash mark, the APMR IR MIL reticle can help you quickly lock in your target and set holdover positions and leads for a moving target. The illuminated 18 mil span cross lines with 0.5 mil hash marks and 0.2 mil hash marks from 7 mil to 9 mil on three directions provide finer details that helps the shooter quickly locate the target and find a holdover position within higher level of precision and confidence.

### ARGOS BTR GEN2 APLR2 FFP IR MOA

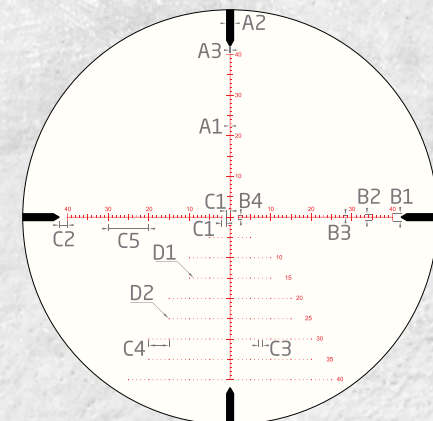

**APLR2 FFP IR MOA** reticle has a large illuminated center with 1 moa hash mark increments and drop lines in 5 moa increment on vertical direction down to 40 moa, both of which help you quickly lock in your target and set holdover positions. The illuminated portion has a 2 moa span center cross with illuminated cross line extends to 40 moa on both vertical and horizontal direction. The unique design of having droplines going down to 40 moa with 5 moa between each drop line and 1 moa hash marks in between provide excellent hold over positions for long precision shooting.

ATSR16 SFP IR MOA	A1	A2	B1	B2	B3	B4	C1	C2	C3	C4	D1	D2	E													
	.4	1.38	1	2	3	4	2	2	2	5	20	18.5	5													
AHMR SFP IR MOA	A1	A2	B1	B2	B3	B4	C1	C2	C3																	
	.12	1.5	.5	1	.5	1.5	1	1	2																	
APRS4 SFP IR MIL	A1	A2	B1	B2	B3	B4	C1	C2	C3	D1																
	.04	.4	.1	.18	.4	.15	.2	.5	1	.1																
ATSR4 SFP IR MOA	A1	A2	B1	B2	B3	B4	B5	C1	C2	C3	C4	C5	C6	C7	C8	C9	C10	C11	C12	C13	C14	C15	D1	D2	D3	D4
	.3	.8	1.5	1.06	1.3	1.7	25	1.07	2.25	2	2.7	2.8	3.4	3.7	2.4	5.6	9.5	14.6	3.47	6.9	11.2	3	1.4	16.5	19	.5

ATSR3 SFP IR MOA	A1	A2	B1	B2	B3	B4	C1	C2	C3	D1	D2	D3		
	.45	1.5	2	6	1.5	3	4	60	2	.5	12	16		
APLR2 FFP IR MOA	A1	A2	A3	B1	B2	B3	B4	C1	C2	C3	C4	C5	D1	D2
	.11	2	.3	2	1.5	.5	1	1	2	1	5	10	.2	.3
APMR FFP IR MIL	A1	A2	A3	A4	B1	B2	B3	C1	D1	D2	D3	D4	D5	
	.02	.4	.05	.1	.2	.4	.3	2	.5	1	.2	1	.2	
APLR2 FFP IR MOA	A1	A2	A3	B1	B2	B3	B4	C1	C2	C3	C4	C5	D1	D2
	.14	2	.3	2	1.5	.5	1	1	2	1	5	10	.2	.3





### ARGOS BTR GEN2 APMR FFP IR MIL

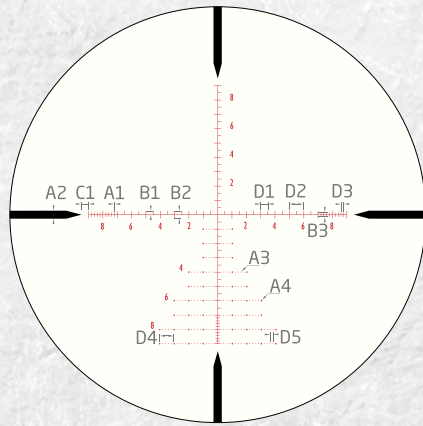

**APMR FFP IR MIL** reticle is designed to maximize your performance on long and mid-distance shooting with illuminated center cross and 0.5 mil hash mark, the APMR IR MIL reticle can help you quickly lock in your target and set holdover positions and leads for a moving target. The illuminated 18 mil span cross lines with 0.5 mil hash marks and 0.2 mil hash marks from 7 mil to 9 mil on three directions provide finer details that helps the shooter quickly locate the target and find a holdover position within higher level of precision and confidence.

### ARGOS BTR GEN2 ATSR5 SFP IR MOA

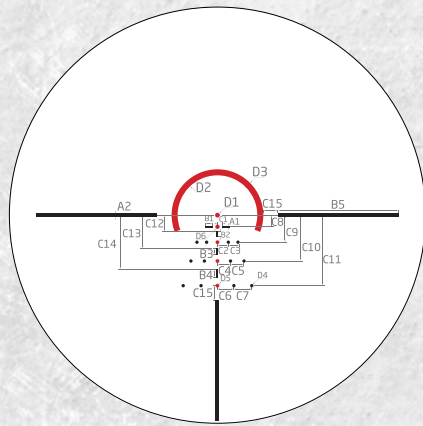

**ATSR5 SFP IR MOA** reticle is calibrated for a 68 grain Hornady and 69 grain Sierra cartridges, and suitable for any 5.56 Nato/.223 caliber rifle using a 200 yard zero. The 25 MOA horizontal and lower 1/3rd cross-hairs quickly draw the shooters eye to the illuminated 19 MOA horseshoe and 1.4 MOA center dot. The 19 MOA horseshoe is designed to bracket a silhouette target at 100 yards. With a 200 yard zero, the precise .5 MOA elevation holds compensate for 300, 400, 500, and 600 yards and 0, 5, and 10 MPH winds.

### ARGOS BTR GEN2 BLR SFP MOA

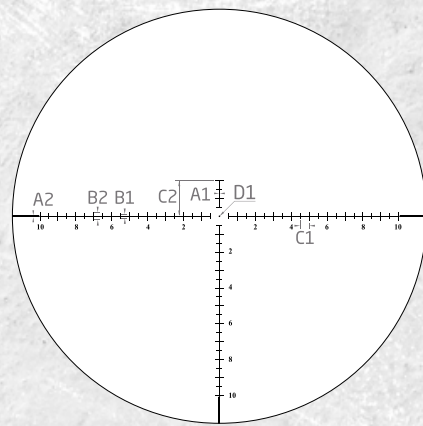

**BLR SFP MOA** reticle is designed to maximize your performance for both Bench Rest and F-Class shooting applications. Fine line thickness of the reticle (0.016 MOA) allows for pinpoint precision at extreme ranges, especially on smaller targets. A non-illuminated floating center dot (0.09 MOA thick) provides a precise aiming point. This reticle combined with the Argos BTR Rifle Scope provides the perfect solution.

### TALOS BTR APLR2 FFP IR MIL

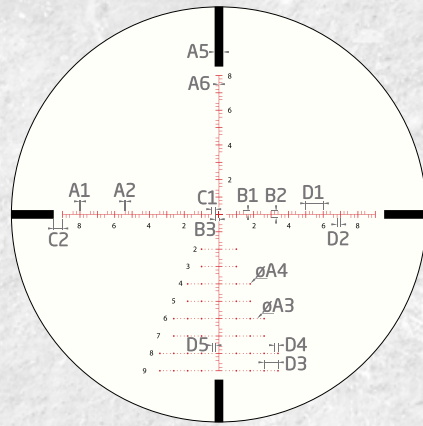

**APLR2 FFP IR MIL** reticle is designed to maximize your performance on precision long and mid range shooting with accurate ranging capability. It will help you quickly determine distance, holdover positions, windage correction and leads for a moving target. The unique design of fine .2 mil hach mark, having .2 and .4 on one side of either horizontal or vertical line and .6 and .8 on another side, helps the shooter quickly locate a holdover position with .2 mil increments within a blink of an eye. The illuminated fine reticle provides excellent low light visibility and windage holdovers on the bullet droplines all the way up to 9 mils with .2 mil marks increments between.

### TALOS BTR AHSR14 SFP IR MIL

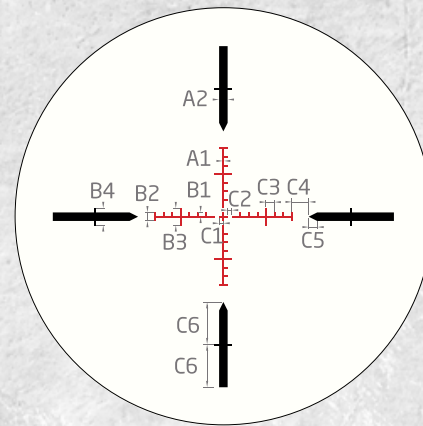

**AHSR 14 SFP IR MIL** reticle is designed to maximize your performance on short range shooting with illuminated 1 mil center cross and 1 mil hash marks increments extended to 8 mils on both horizontal and vertical directions and can help you quickly spot your target and set holdover positions and leads for a moving target. The illuminated 16 mil center with an 1 mil center cross (0.5 mil from center to the side) and 10 mil black lines enable a shooter to quickly locate the target and put it right on the center cross within a blink of an eye. The illuminated portion of the reticle provides excellent low light visibility.

### TALOS CENTER X

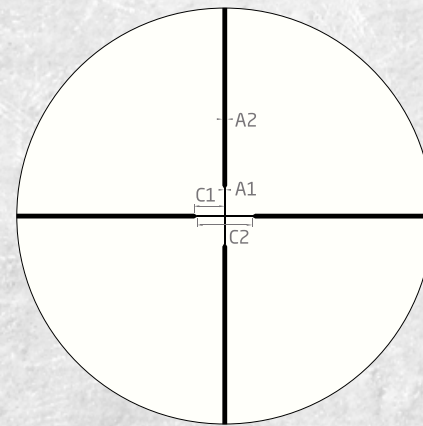

**Center X** reticle is a perfect choice for shooters wishing to have a clear field of view with a more traditional crosshair. The Center X reticle allows shooters to quickly view their target while maintaining one distinct aiming point on their reticle. The heavy posts stand out nicely against cover and in twilight conditions, pointing boldly to the intersection.

### TALOS ATMR1 SFP IR MIL

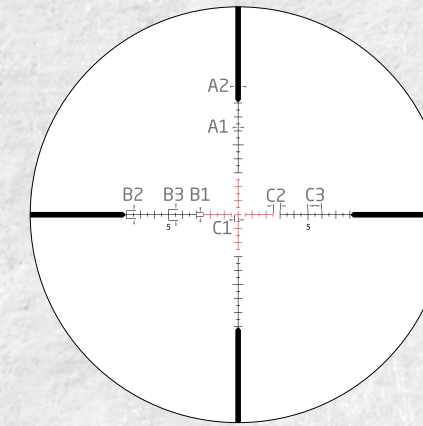

**ATMR1 SFP IR MIL** reticle is perfect for shooting at the range or competing in a competitions. The customized Mil hash mark design helps to eliminate any guesswork with holdover and windage adjustments. The illuminated reticle is great for low light situations when you need to count on a good, accurate shot.

### TALOS MIL DOT

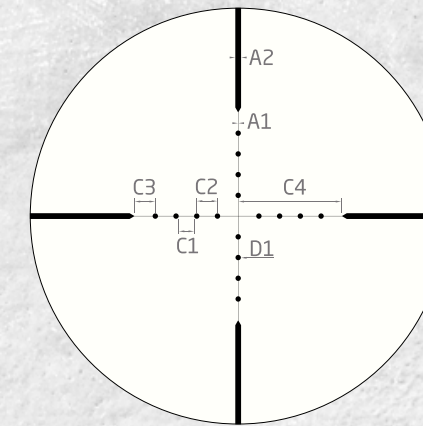

**Mil Dot** reticle is one of the most accurate, versatile means of estimating ranges using a manual optical device. The Mil Dot allows the user to do range estimations, holdover and wind drift compensation as well as for precise leads for moving targets.

APMR FFP IR MIL	A1	A2	A3	A4	B1	B2	B3	C1	D1	D2	D3	D4	D5															
	.02	.4	.05	.1	.2	.4	.3	2	.5	1	.2	1	.2															
ATSR5 SFP IR MOA	A1	A2	B1	B2	B3	B4	B5	C1	C2	C3	C4	C5	C6	C7	C8	C9	C10	C11	C12	C13	C14	C15	D1	D2	D3	D4	D5	D6
	.3	.8	1.5	1.06	1.3	1.7	25	1.07	2.25	2	2.7	2.8	3.4	3.7	2.4	5.6	9.5	14.6	3.47	6.9	11.2	3	1	16.5	19	.7	.8	.9
BLR SFP MOA	A1	A2	B1	B2	C1	C2	D1																					
subtension valid @ 40x	.016	.1	.3	.5	.5	2	.09																					
APLR2 FFP IR MIL	A1	A2	A3	A4	A5	A6	B1	B2	B3	C1	C2	D1	D2	D3	D4	D5												
	.04	.025	.05	.1	.5	.025	.1	.2	.2	.2	.5	1	.2	1	.2	.2												

AHSR14 SFP IR MIL	A1	A2	B1	B2	B3	B4	C1	C2	C3	C4	C5	C6
subtension valid @ 4x	.13	1	.5	1	2	2	.5	.5	1	2	1	5
CENTER X	A1	A2	C1	C2								
subtension valid @ 12x (3-12x40)	.18	.7	4.5	9								
ATMR1 SFP IR MIL	A1	A2	B1	B2	B3	C1	C2	C3				
subtension valid @ 12x 16x and 18x	.02	.5	.3	.6	.8	.25	.5	1				
MIL DOT	A1	A2	C1	C2	C3	C4	D1					
subtension valid @ 10x	.05	.25	.75	1	1	5	.25					





### TALOS BDC 600 IR

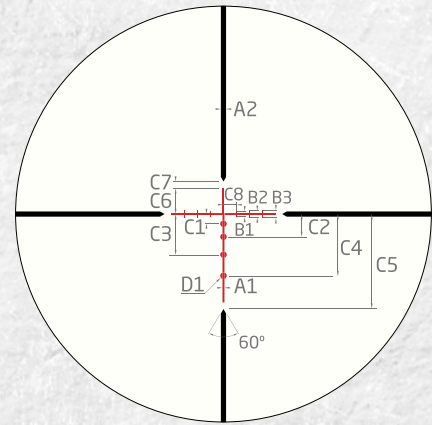

**BDC 600 IR** was designed to deliver a high level of precision at extended targets that can be used with today's most popular rifle cartridges.

### NEOS BDC22 RIM FIRE

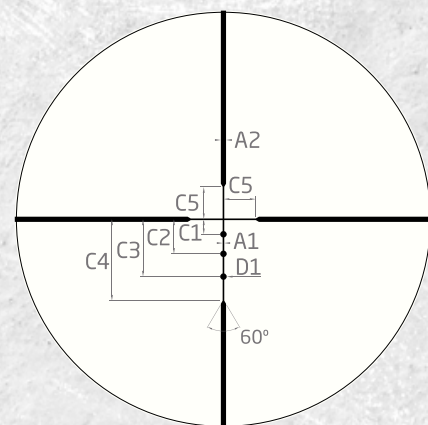

**BDC22 Rim Fire** reticle was designed specifically for rimfire. This reticle allows shooters to compensate for bullet drop at extended shooting distances. When using a .22 LR with a muzzle velocity of approximately 1,250 feet per second, this reticle is designed to be zeroed at 50 yards, providing bullet drop compensation for 75, 100, 125 and 150 yards.

### NEOS CENTER X

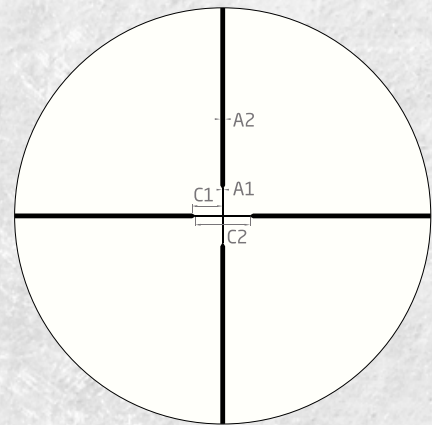

**Center X** reticle is a perfect choice for shooters wishing to have a clear field of view with a more traditional crosshair. The Center X reticle allows shooters to quickly view their target while maintaining one distinct aiming point on their reticle. The heavy posts stand out nicely against cover and in twilight conditions, pointing boldly to the intersection.

### NEOS BDC 500 IR

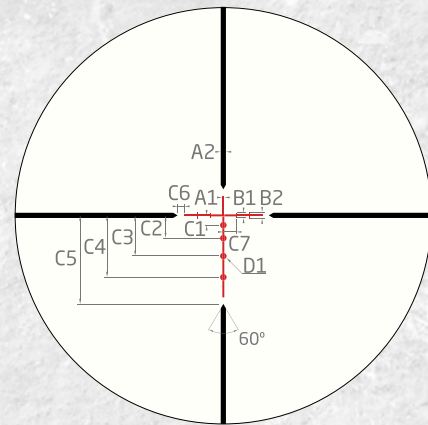

**BDC 500 IR** was designed to deliver a high level of precision at extended targets that can be used with today's most popular rifle cartridges.

BDC 600 IR	A1	A2	B1	B2	B3	C1	C2	C3	C4	C5	C6	C7	C8	D1
subtension valid @ 12x 16x and 18x	.3	.8	.8	1	1.2	1.5	3.5	6.25	9.5	13.6	4	1	2	1
CENTER X	A1	A2	C1	C2										
subtensions valid @9x (3-9x40)	.25	.9	6.5	13										
subtensions valid @12x (4-12x40)	.18	.7	4.5	9										
subtensions valid @18x (6-18x44)	.12	.5	3.2	6.5										
BDC22 RIM FIRE	A1	A2	C1	C2	C3	C4	C5	D1						
subtensions valid @9x, 12x, 18x	.25	.8	2.3	5.3	8.8	12.5	5	1						
BDC 500 IR	A1	A2	B1	B2	C1	C2	C3	C4	C5	C6	C7	D1		
subtensions valid @9x, 12x, 18x	.3	.8	.8	1	1.5	3.5	6.25	9.5	13.6	1	2	1		

### MIDAS RED DOT SIGHT RETICLES

When you need fast, effective, accurate, simple and reliability, Athlon Optics Red Dot family of products is just what you need. The Red Dot offers a bright red light for easy vision in all lighting situations. When the stakes are at their highest, whatever your needs are, trust your shot with Athlon Optics.

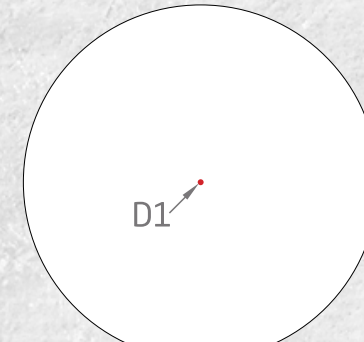

TSR1 (D1 = 3 MOA)

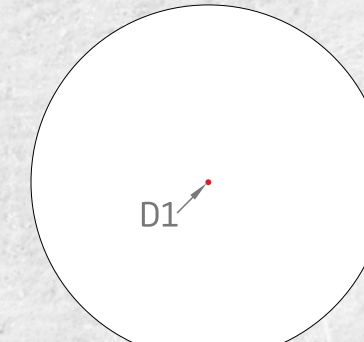

TSR2 (D1 = 2 MOA)

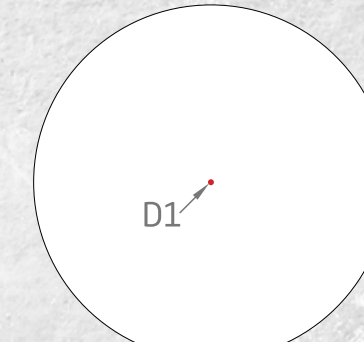

TSR3 (D1 = 2 MOA)

### MIDAS PRISM SCOPE RETICLES

Designed specifically for fast target acquisition, Athlon Optics Prism Scopes are high performing, durable and reliable. Ideal for close to medium range shooting and rugged for any situation you may encounter.

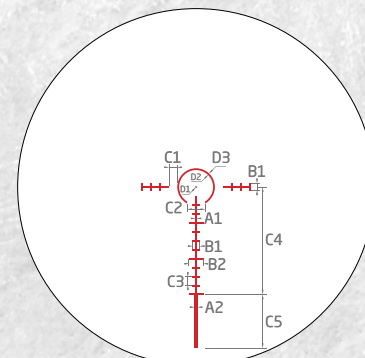

TSP3 - RED

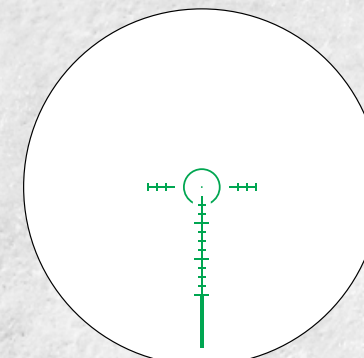

TSP3 - GREEN

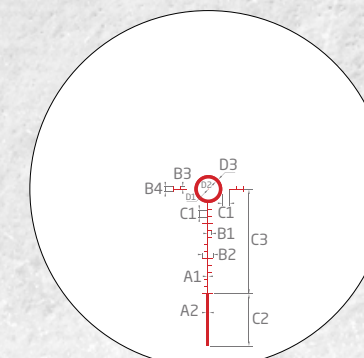

TSP4 - RED

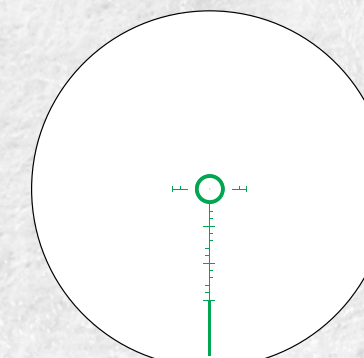

TSP4 - GREEN

TSP3	A1	A2	B1	B2	C1	C2	C3	C4	C5	D1	D2	D3
subtensions in MOA	.6	1.8	4	8	4.5	10	5	60	30	1	19	21
TSP4	A1	A2	B1	B2	B3	B4	C1	C2	C3	D1	D2	D3
subtensions in MOA	.45	1.5	2	6	1.5	3	4	30	60	.5	12	16





# ACCESSORIES

## BINOCULAR HARNESS

The Athlon Optics Binocular Harness is the most functional, versatile binocular system in the market. It holds your binoculars tight to your chest, and is designed for quiet, one-handed use. With the multiple shoulder and neck adjustments, this allows the binocular harness to hold close to your chest and prevent sag and bounce when crawling or running. The harness allows for a full range of motion while the binoculars are in use

### KEY FEATURES

- Water Proof Material
- Quiet Material
- Quick and Easy Access
- Fits Most Binocular Sizes

### OTHER FEATURES

Fold-Down Lid Retention, Magnetic Closure for Quiet Access, 4 Point Harness for All Day Comfort, Internal Mesh Pocket, Vented Shoulder Straps, Layered Interlock Close Mesh Side Pockets



## PRECISION RINGS

New for 2020, Athlon Precision Rings are made in the USA from High Strength Aluminum Alloy. Designed for precision rifles including magnum calibers.



TUBE DIAMETER	1"	30mm	30mm	30mm	34mm	34mm	34mm
SIZE	MED	LOW	MED	MSR	LOW	MED	MSR
HEIGHT	.9	.868	.993	1.443	.944	1.069	1.519

## SCOPE SUNSHADE

Cronus BTR, Cronus, Ares ETR, Ares BTR GEN2, Ares BTR, Midas TAC, Midas BTR GEN2, Midas BTR, Midas HMR, Helos BTR, Argos BTR GEN2, Argos BTR, Talos BTR riflescopes, black matte surface finish, and 4.5 inches long (sizes in 56, 50, 44mm).



I want to thank Athlon, their great team in the warranty department, and especially Drake who returned all my calls and kept me informed. I sent them a scope I had received from a vendor broken.

In less than 10 days I had a new scope in my hand. My hunt was dependent on getting a scope back, in a certain time, and Athlon went out of their way to make sure that happened. Not only is it a fantastic scope with a great warranty but their customer service is truly out of this world!

This experience makes it an easy choice for my next rifle, I am an Athlon Optics customer for life!

- Michael Stripling

This summer while at the range getting ready for a PRS shoot my rifle tipped over while on the bipod. It hit hard on the windage turret. I called Athlon and was told to return it and it would be checked to make sure it was ok. 1 week after sending the scope in a new arrived at my door. This is service that was unexpected. I have since purchased another Athlon scope.

Thank you for the great customer service Athlon!!

- Shon Berry

Athlon Optics is awesome company that stands behind their product. I have to say after my rifle slid off the sandbags at the range and hit the concrete Athlon was great about getting me back up and running.

Lifetime warranty u can't beat it. I wish I had one on all my rifles.

- Lynn Atkinson

I purchased a set of Athlon Argos binoculars in 2017 from 5-H Designs. They were great! Only problem is my 10 year old Grandson dropped them about 8-10 feet on the eye cups, rendering both cups useless. This was no fault of Athlon but I thought I would check with them to get them fixed at my expense.

When I contacted them and talked to Drake he told me to send them in. I did and in about a week or so, I had a brand new pair at my house!! I can't say enough about Athlon and the way they stand behind their products. That was not a product failure, that was an accident that really shouldn't have been covered.

I am going to purchase a new rifle scope soon and it will be an Athlon! Thanks guys! Great products and Great warranty.

-Tim Kingcade



LIFETIME WARRANTY

athlonoptics.com





# ATHLON ENTHUSIASTS THANK YOU

for supporting our mission

801 N Meadowbrook Dr,  
Olathe, Kansas 66062

TOLL FREE: 1-855-913-5678  
contact@athlonoptics.com  
www.athlonoptics.com